



<http://www.adsequip.com/>

Installation manual of AJ16US dental chair

Copyrights

ADS makes no warranty of any kind with regard to this material, including but not limited to, the implied warranties of merchantability and fitness for a particular purpose. ADS shall not be held liable for any errors contained herein or any consequential or other damages concerning furnishing, performance or use of this material. The information in this document is subject to change without notice. If you find any problems in the documentation, please report them to us in writing. ADS does not warrant that this document is error-free.

No part of this document may be copied, reproduced, altered, or transmitted in any form or by any means, electronic or mechanical, including photocopying, recording, or by any information storage and retrieval system, without prior written permission from ADS.

The document is intended to be used in conjunction with the equipment.

Comments and feedback

Please contact us if you have any feedback and opinions on this document:

Add: 1590 S Milliken Ave., unit A, Ontario, CA 91761

Tel: (626) 620 0456

E-mail : sales@adsequip.com

<http://www.adsequip.com/>

Product service

If you want to get service information, please contact the local dealer authorized by ADS company.

Technical support tel: 800 488 9708

CONTENTS

1	Introduction.....	1
	1.1 Products information.....	1
	1.2 Symbols explanation.....	1
2	Composition.....	3
3	Parameters.....	4
	3.1 Specifications.....	4
	3.2 Size.....	4
4	Preparations.....	5
	4.1 Attentions.....	5
	4.2 Tools recommended.....	6
	4.3 Installation requirements.....	7
5	Installation.....	7
	5.1 Place the chair	7
	5.2 Fix the chair.....	8
	5.3 Install the backrest.....	9
	5.4 Install the headrest	10
	5.5 Install backrest upholstery.....	10
	5.6 Install seat upholstery.....	11
6	Operations.....	12
	6.1 Power.....	12
	6.2 Chair positioning.....	13
	6.2.1 Operate by foot control.....	13
	6.2.2 Control panel and function set	14
	6.2.3 System state	14
	6.2.4 Initial settings of the chair.....	15
	6.2.5 Initial settings description.....	16
	6.2.6 Chair positions description.....	17
	6.3 Dual articulating headrest.....	18
	6.4 Armrest	19
	6.5 Chair rotation.....	20
7	Regulation & maintenance.....	21
	7.1 Remove the upholstery	21
8	Reserved lines	23
9	Upholstery Maintenance Instruction.....	27
10	Connecting diagrams.....	28







1 Introduction













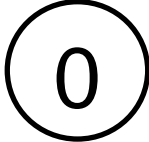

1.1 Product information

- **Name:** Dental chair
- **Model:** **AJ16US**
- **Working conditions:**
 - ① Ambient temperature: 5 °C ~ 40 °C;
 - ② Relative humidity: ≤ 80%;
 - ③ Air pressure: 12.5 ~ 15.4psi;
 - ④ Nominal voltage: AC110 V ± 22 V;
 - ⑤ Nominal frequency: 60 Hz ± 1 Hz;

1.2 Symbols explanation

Table 1

Symbol	Explanation
 Manufacturer	 EU representative
 Producing date	 Serial number.
 Place with care	 Keep dry

Symbol	Explanation
 <p>Refer to attached document</p>	 <p>Notice</p>
 <p>Avoid electric shock</p>	 <p>Backrest Down</p>
 <p>Ground protection</p>	 <p>Backrest Up</p>
 <p>Original position</p>	 <p>Chair Down</p>
 <p>Set</p>	 <p>Chair Up</p>
 <p>Spitting position</p>	 <p>Program Chair Position 1</p>
 <p>Program Chair Position 2</p>	 <p>Program Chair Position 3</p>

2 Composition

AJ16US dental chair (figure 1) combined with new design concepts , provide a good balance for usability ,simplicity and comfortability.

Figure 1 AJ16 US Dental Chair



Item	Component	Item	Component
1	Headrest	6	Armrest button
2	Backrest	7	Touch pad control panel
3	Armrest	8	Lifting arm
4	Seat	9	Junction box
5	Foot control		

3 Parameters

3.1 Specifications

Load bearing

Patient bearing: Max 135kg



Tip: Specifications are subject to change without notice.

3.2 Size (unit: inches)

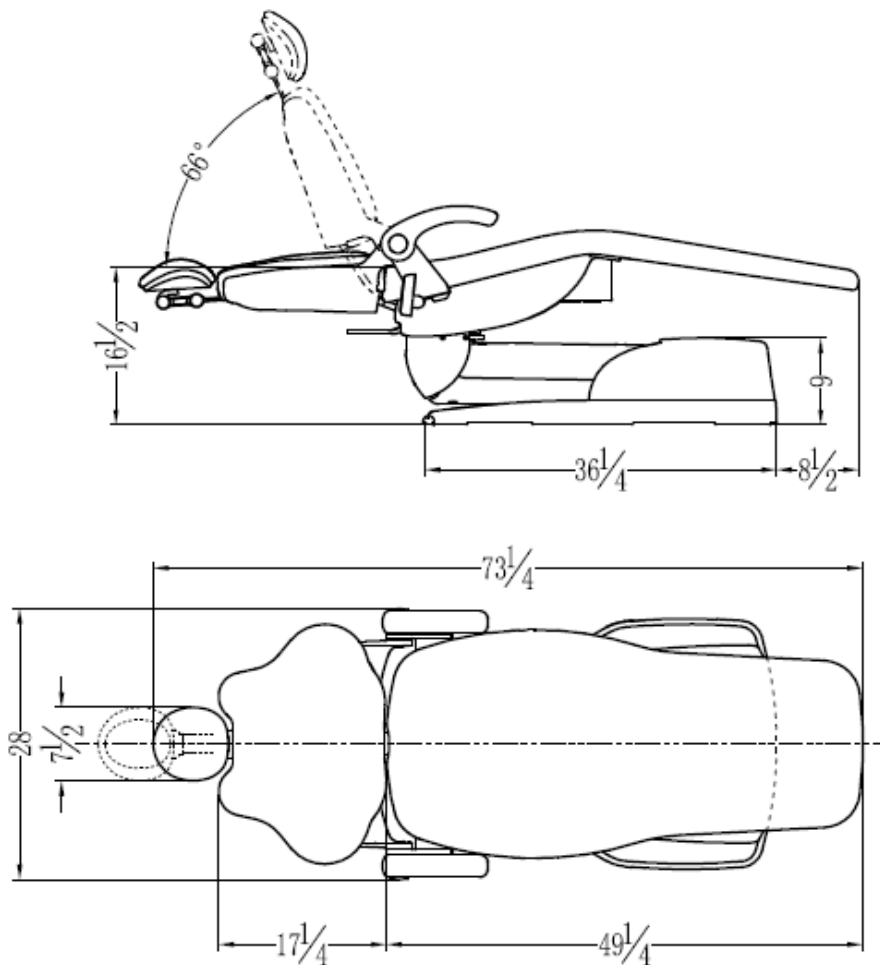

4 Preparations

4.1 Attentions

Before install the unit, you should:

- Clear all the debris in the room , and clean the floor thoroughly.
- Apply two manually operated valves for the air and water source.
- Exhaust the dirty water and air before connecting.

Before install the unit, please read the manual carefully:









- Input voltage AC110 V ,50/60 Hz.
- Make sure the dental unit is in good grounding .
- All the electrical components and connections should be made by an authorized technician.
- Only fuse and accessories recognized by ADS technician can be used.
- This device should not operate in the environment of high temperature, high humidity, vibration ,flammability, unbalance, or dusty.
- Only the authorized spare parts can be used in this device.
- This dental unit should not come into contact with any object in its operational range of movement.
- This device can not be used in the environment of strong magnetic, electromagnetic.

Leather maintenance:

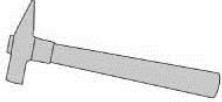
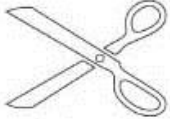
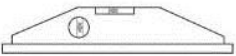
- 1、 No organic solvent or alkaline detergent (such as: gasoline、 alcohol ,etc.), or the leather will crack, be smelly or fade;
- 2、 No exposure, keep the room in good ventilation (exposure can cause the leather crack, bad ventilation lead to go mouldy) ;
- 3、 Mention the patient to remove edged tools(like keys)before operation, to avoid scratch the leather.

4.2 Tools recommended

The tools and instruments need to prepare before installation.

	Electrical drill		Pincers
	Hammer		Scissors
	Leveling instrument		Flat-bladed Screw driver
	Phillip screw driver		Allen wrench
	Spanner		Hexagon socket wrench

4.3 Installation requirements

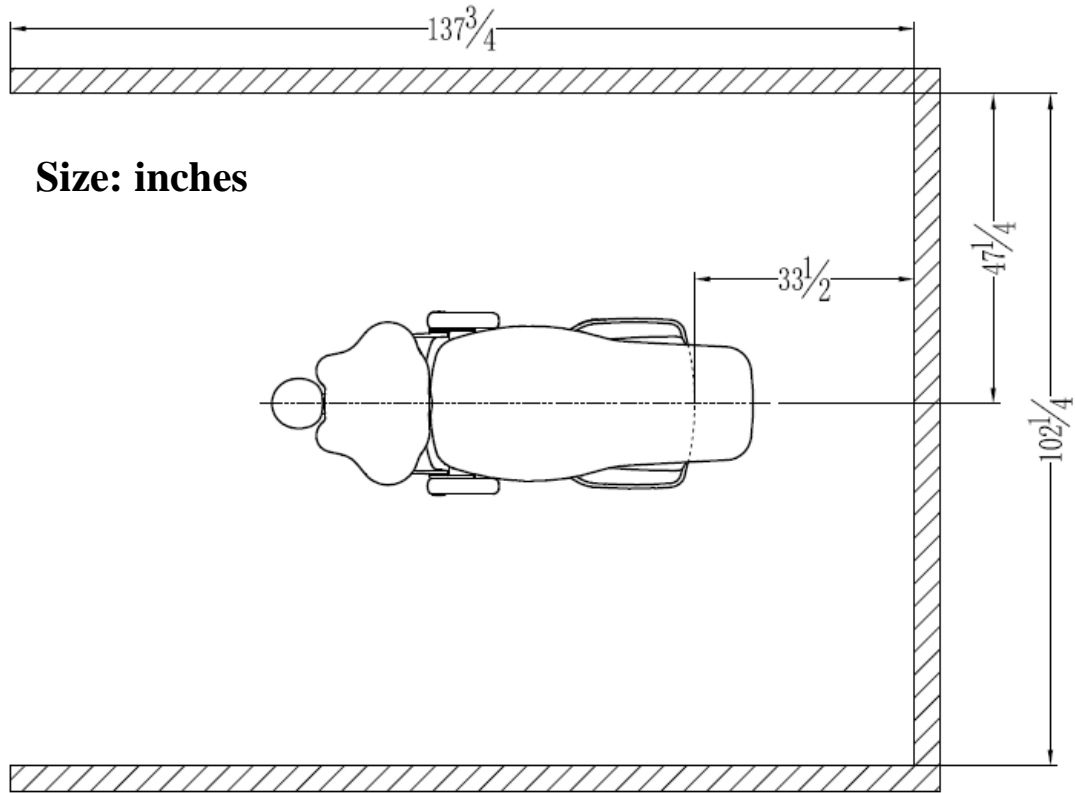

5 Installation

5.1 Place the chair

1. Remove all debris and cardboards around the chair.
2. Hold the handrail and the front of the frame, uplift the chair and place the chair on the right place.
3. Remove binding belt and packages.
4. Remove the front shell.

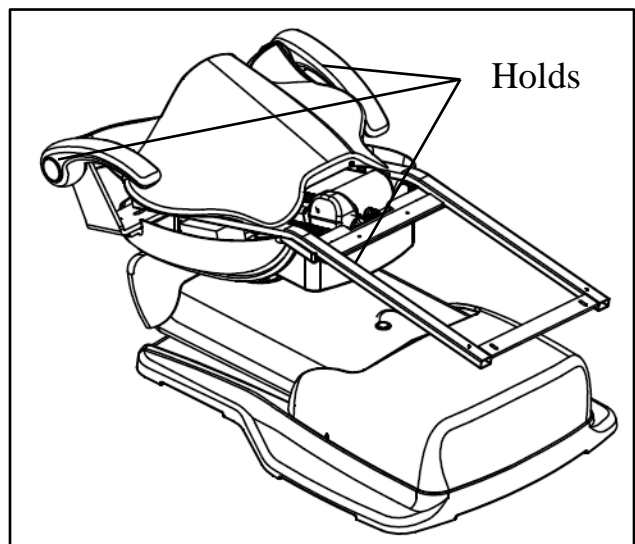

5.2 Fix the chair



Attentions:

- 1.The chair must be fixed on the floor for ensuring stability, for it can be seriously damaged by wrong fixation.
- 2.Check out the material of the floor on the installing place. Please contact the authorized contractor to thickening the floor if its thickness is less than 82 mm.

- 1、 Power on and activate the unit.
- 2、 Step the button  on foot control , raise the unit.
- 3、 Unit switched off and power disconnected.
- 4、 Remove the cover and mark the installing position , then move the unit away.

Drill on the marked position, press the explosive bolt, then return the unit to its position and tighten the screw.

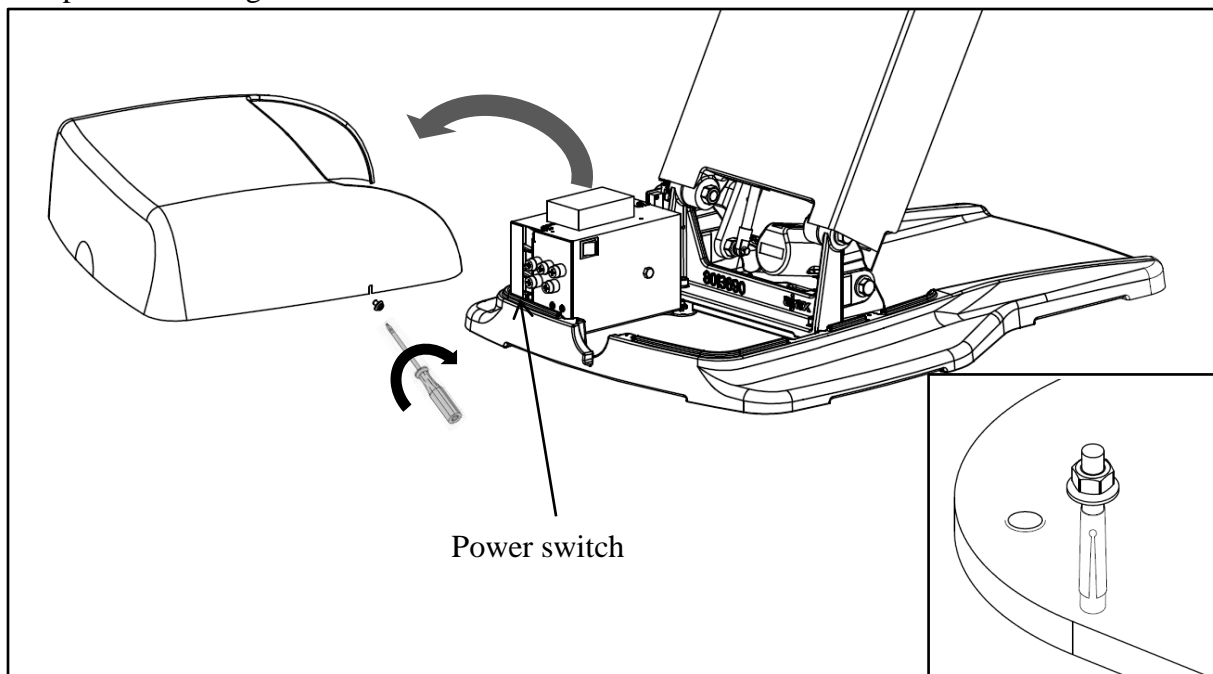

5.3 Install the backrest

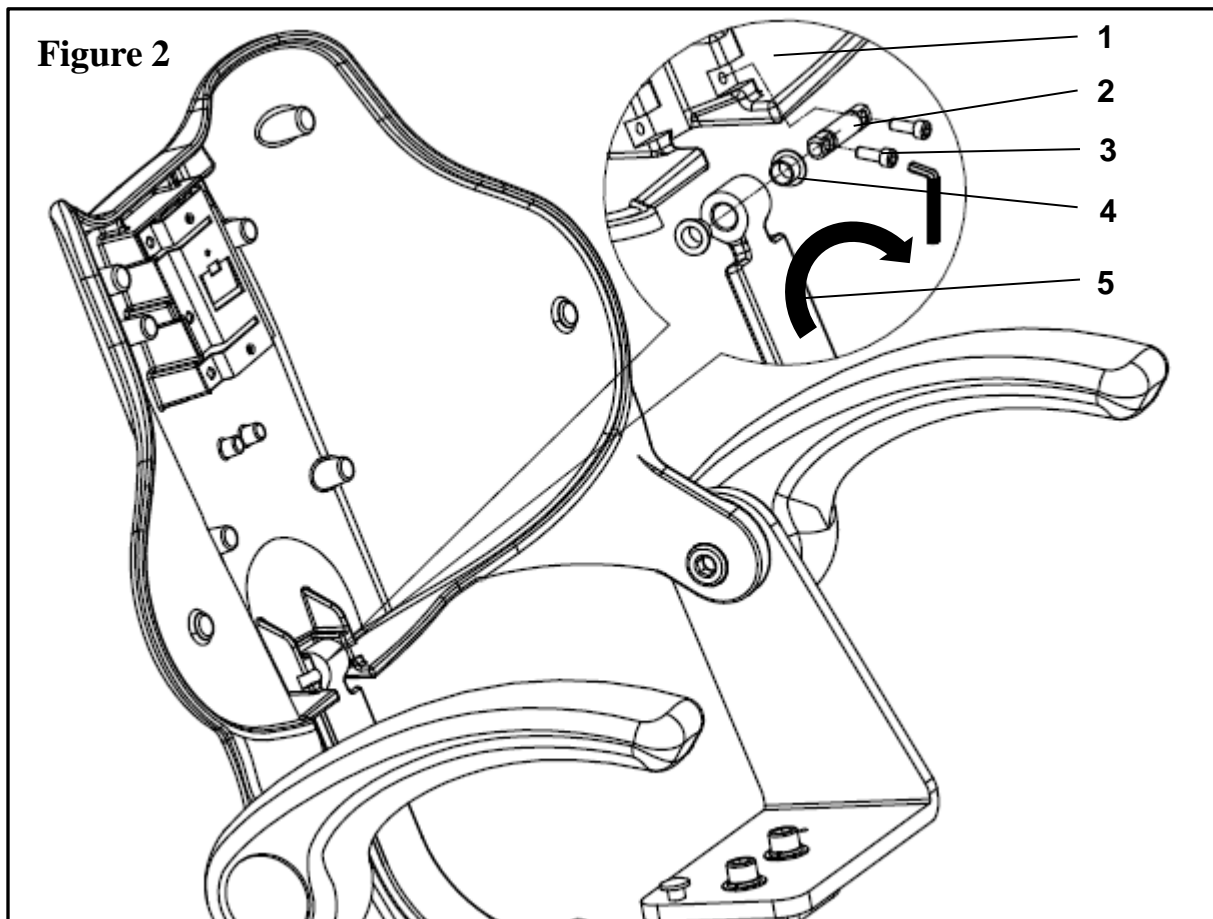

Pass the fixing shaft through the backrest push rod, fix the shaft on backrest with the cap screw assembly.

Tool:
5mm Allen wrench

1	Backrest
2	Fixing shaft
3	M6*20 Hexagon socket cap screw assembly
4	GFM-1214-10 Slide bearing
5	Push rod

5.4 Install the headrest

Figure 3

Push the headrest glidebar into the slot of the backrest.

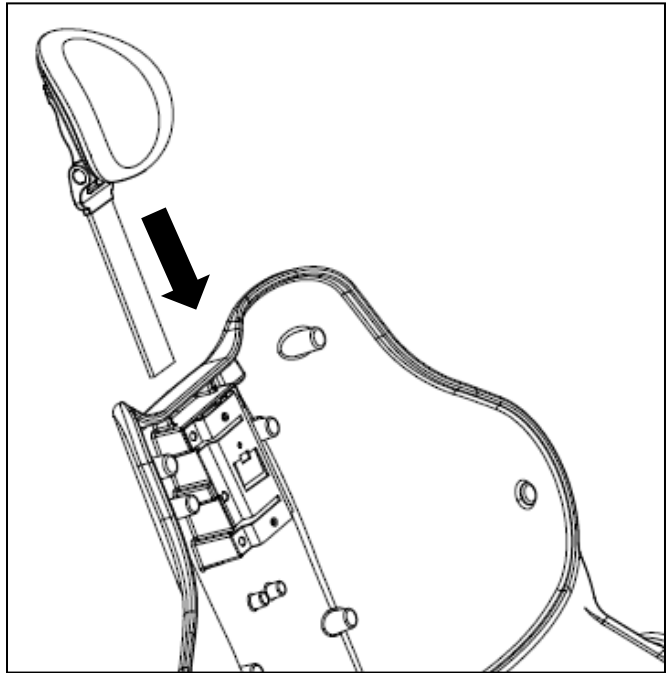

5.5 Install backrest upholstery

Figure 4

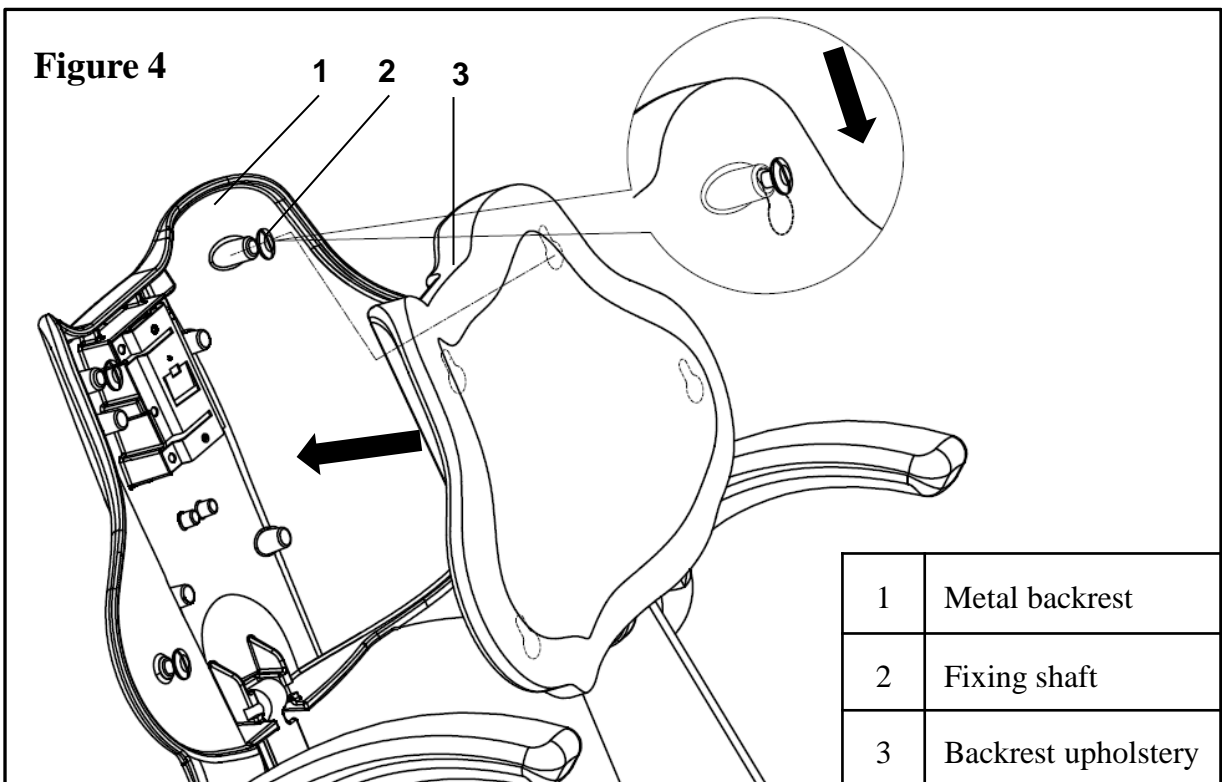

When installing the upholstery, you should put the upholstery on the backrest with the shaft head pass through corresponding keyholes of the upholstery, then push the upholstery in force till it's fixed.

6 Operations

6.1 Power

The power switch of the power box controls power supplying of the dental chair and its delivery system.

Switch on and you can get the power, switch off for not using in a long term, or before maintenance .

Figure 6

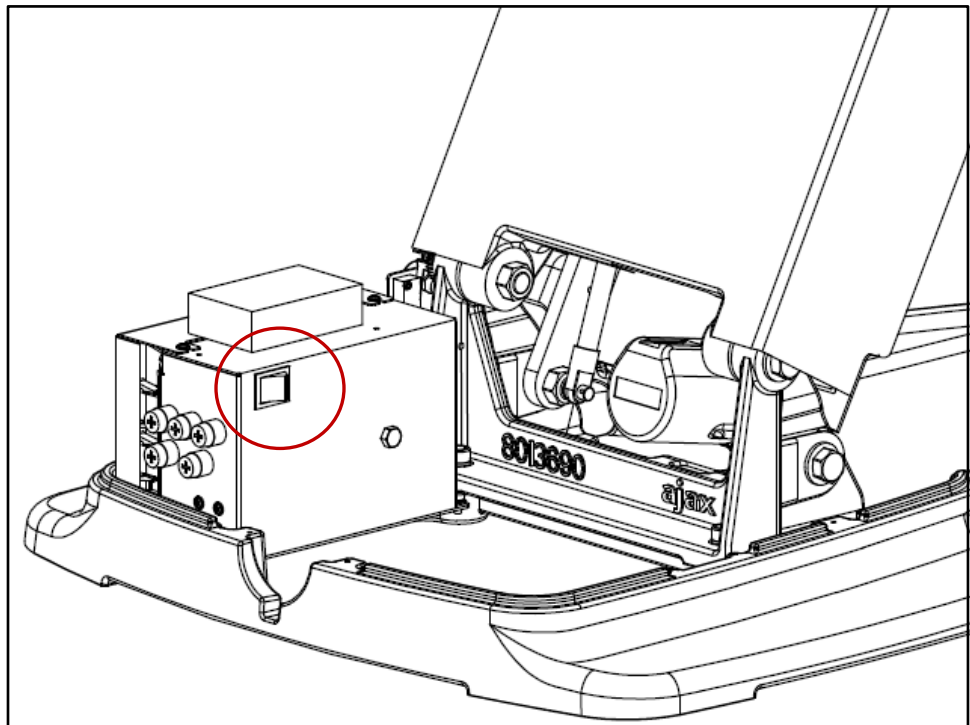

6.2 Chair positioning

You can operate the chair manually or by foot control.

6.2.1 Operate by foot control

Raise or low the chair by pressing base up/down button, step on the up/down arrow on the foot control till the chair is in best position.

Move the backrest by pressing backrest up/down button, step on the left/right arrow till the chair is in best position

Figure 7



0	Original position
1	Program Chair Position 1
2	Program Chair Position 2
P	Set
LP	Spitting position
←	Backrest down
→	Backrest up
↑	Chair up
↓	Chair down

6.2.2 Control panel and function set

Figure 8

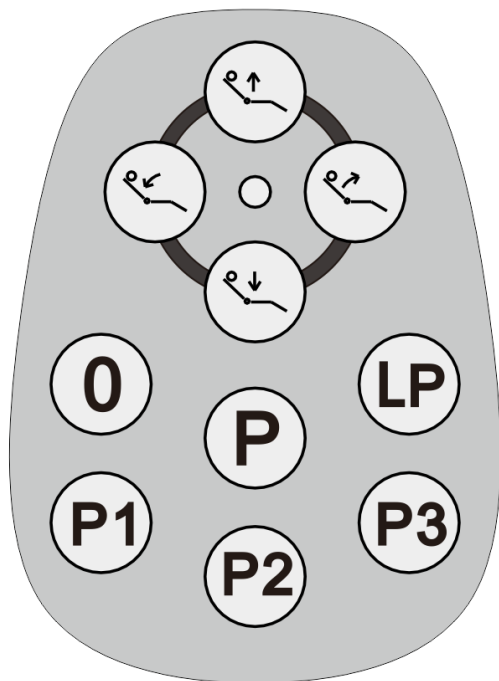

	Original position
	Program Chair Position 1
	Program Chair Position 2
	Program Chair Position 3
	Set
	Spitting position
	Backrest down
	Backrest up
	Chair up
	Chair down

6.2.3 System state

If the indicator light is bright on the control panel, it indicating that the system is normal, and you can operate normally.

6.2.4 Initial settings of the chair

Electric motor system initial settings specification:

Press the “O” button on the main control panel of dentist unit to descend the chair motor till the lower limit switch is triggered, raise the backrest motor till the higher limit switch is triggered. System initialize automatically ,it can be normally performed after initialization finished .



Caution: Electric motor system shall have the initial settings in following situations:

- First installation.
- Motor replacement.
- Main board replacement.
- Limit switch readjustment or replacement.
- Abnormal movement .

Hydraulic system initial settings specification :

1. Press ”P” button about 12 second until the buzzer sound 2 short beeps, enter original setup status; press P1, the buzzer sound 1short beep, escape setup status. This step eliminates the original stroke parameters.
- 2.Press “P” button about 12 second until the buzzer sound 2 short beeps, enter initial setup status , press the four moving chair button to make backrest up and press”0”, and then press the four moving chair button again to make chair up to the highest and the backrest is on the lowest. At this time, press ”LP”and then finish the setting.



Caution: Hydraulic system shall have the initial settings in following situations.

First installation or replacement of mainboard .

Insert/replace/repair any position feedback potentiometer or wiring.

Reset or replace the limit switch..

Reset the motion range of the chair.(Disabled to move or cannot move to desired position.)



Caution :

When setting up the system, do not extent the maximum range of the cylinder to prevent the hydraulic pump from not working properly!

6.2.5 Settings of programming memory position



- Move the chair and backrest to the working position, and adjust dental light to the desired condition (On or Off), press the “P” button (12S) , the indicator light is on (beep 2 time) , (loose button so as not to enter the original setting state) , enters the setup procedure.
- Press the “P1” button , and then press the “P” button one time again,(beep1-2times), setup finished and escape the setup procedure.
- P2, P3 position setup are same step as the P1.

6.2.6 Chair positions description

a. Backrest Up



Press this button continuously and the backrest will move upwards. When the backrest reach the desired position, stop pressing the button and the backrest will stop immediately.

NOTE: If you press the button continuously, when the chair backrest reach the limit position, it will automatically stop the movement.

b. Backrest Down



Press this button continuously and the backrest will move downwards. When the backrest reach the desired position, stop pressing the button and the backrest will stop immediately.

NOTE: If you press the button continuously, when the chair backrest reach the limit position, it will automatically stop the movement.

c. Chair up



Press this button continuously and the chair will move upwards. When the backrest reach the desired position, stop pressing the button and the backrest will stop immediately.

NOTE: If you press the button continuously, when the chair backrest reach the limit position, it will automatically stop the movement.

d. Chair down



Press this button continuously and the chair will move downwards. When the backrest reach the desired position, stop pressing the button and the backrest will stop immediately.

NOTE: If you press the button continuously, when the chair backrest reach the limit position, it will automatically stop the movement.

e. Original position



Press the button, the chair and backrest will move to the original position automatically(Original position : backrest highest , the chair lowest) and light off . Press this button again , the chair returns to former position and light on. The chair shall stop at a new position by halfway stop.

f. Spitting button



Press the button, the chair and backrest will move to spitting position automatically(Spitting position : backrest highest , the chair is still) and light off . Press this button again , the chair returns to former position and light on. The chair shall stop at a new position by halfway stop.

6.3 Dual articulating headrest

Figure 8 Headrest adjustment

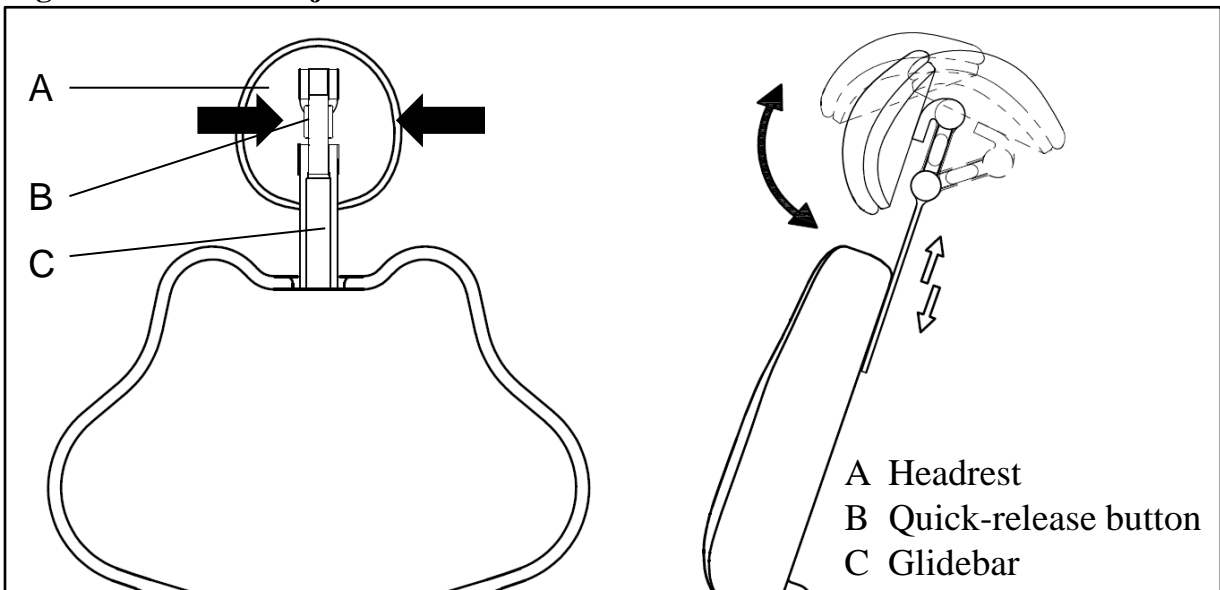

- Press the quick-release buttons to adjust rotation angle of the headrest.
- Headrest extension length : 0-150mm.

Figure 9 Fix the headrest for a wheelchair.

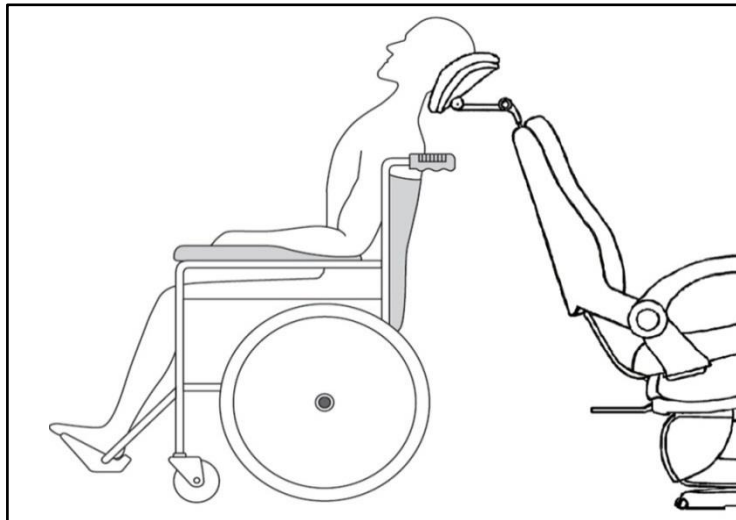

Fix the headrest for a wheelchair:

1. Backrest of the dental chair is fully raised.
2. After reposition the headrest ,raise or descend the chair to adjust heights. Patient's position should also be adjusted to put the wheelchair and dental chair back to back together.
3. Make sure the wheelchair is locked.

6.4 Armrest

The armrest is easy to operate ,which provides convenience to users . Press the button you can rotate the armrest forward or backward .

Figure10 Armrest positioning

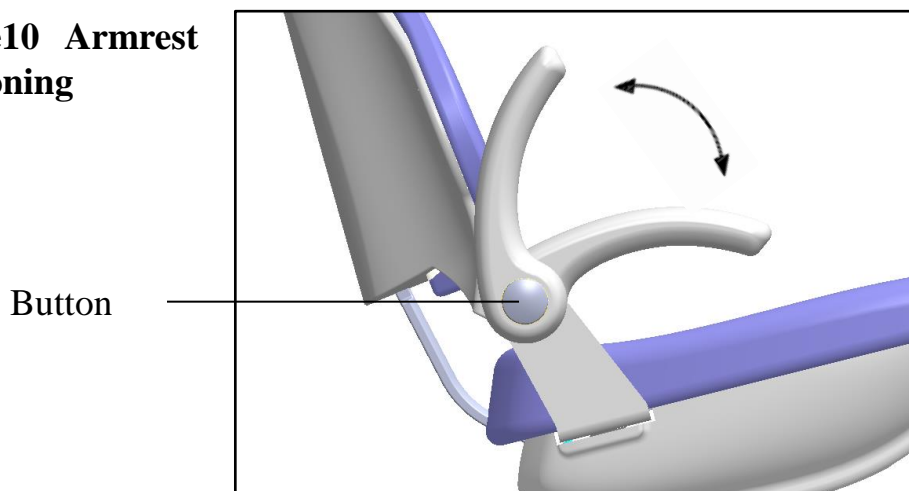

6.5 Chair rotation

Figure 12 Chair rotation

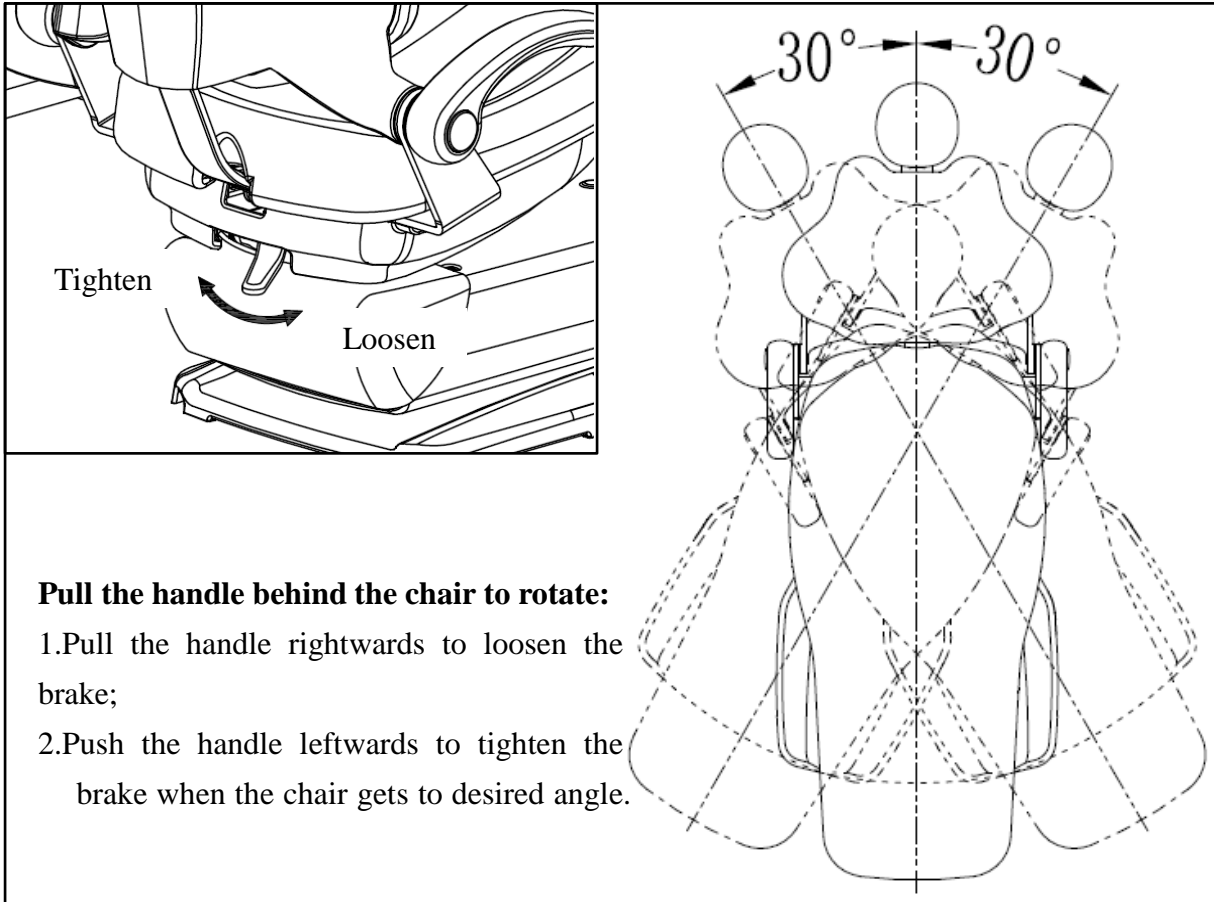
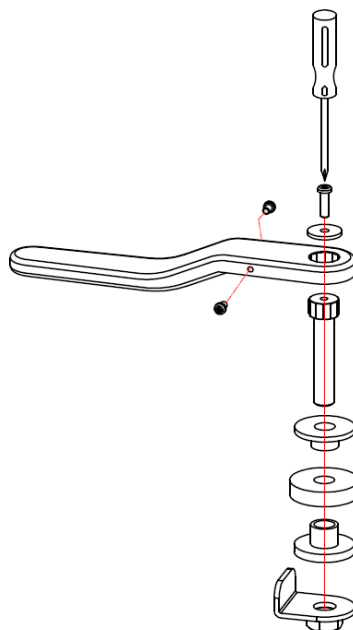

Figure 13 Handle adjustment

You should adjust the tension of handle if the chair can not be fixed or the handle is hard to move.

1. Loosen the set screw by an Allen wrench .
2. Rotate the handle to adjust tension: clockwise to tighten, counterclockwise to loosen;
3. Tighten the screw after adjustment.



7 Regulation & maintenance

7.1 Remove the upholstery

The special design of upholstery is easy to remove and replace .They are installed on backrest, seat and headrest of the chair .

Backrest upholstery

To take off the upholstery from backrest , you should hold the bottom edge of gasket firmly and lift it up (1 inch or 25 mm) , then lift the upholstery from the backrest of the chair (Figure14).

To reinstall the upholstery, you can put the keyhole of gasket on nail head, then push till the gasket is fixed.

Figure 14 Remove the upholstery

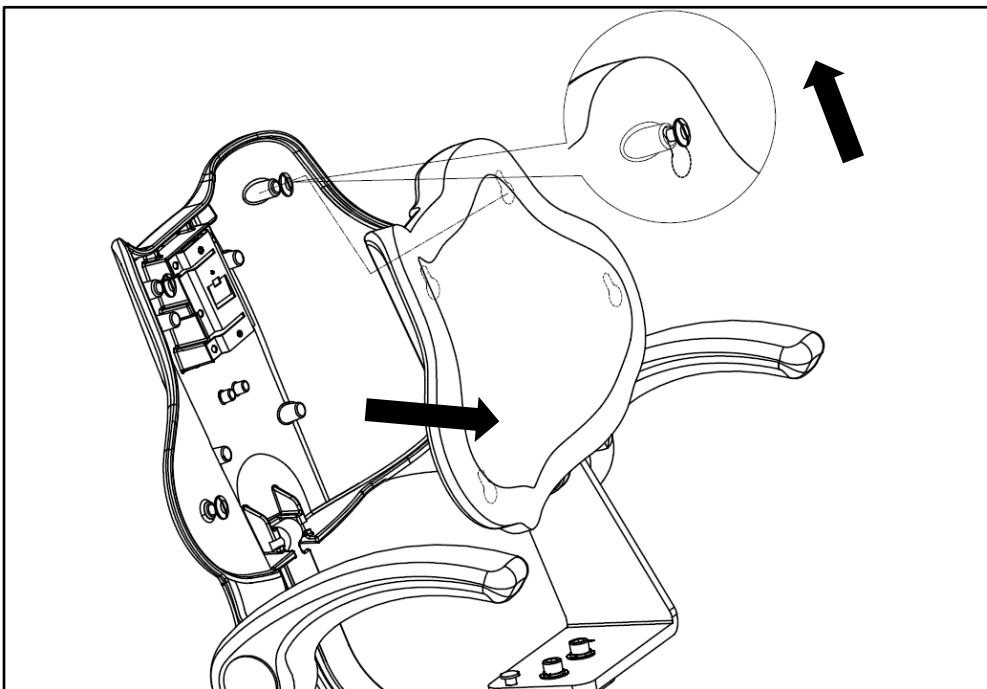

Seat upholstery

Loose the screw at the front end of the upholstery, push the upholstery forward, then remove the seat upholstery.

Figure 15 Remove the seat upholstery

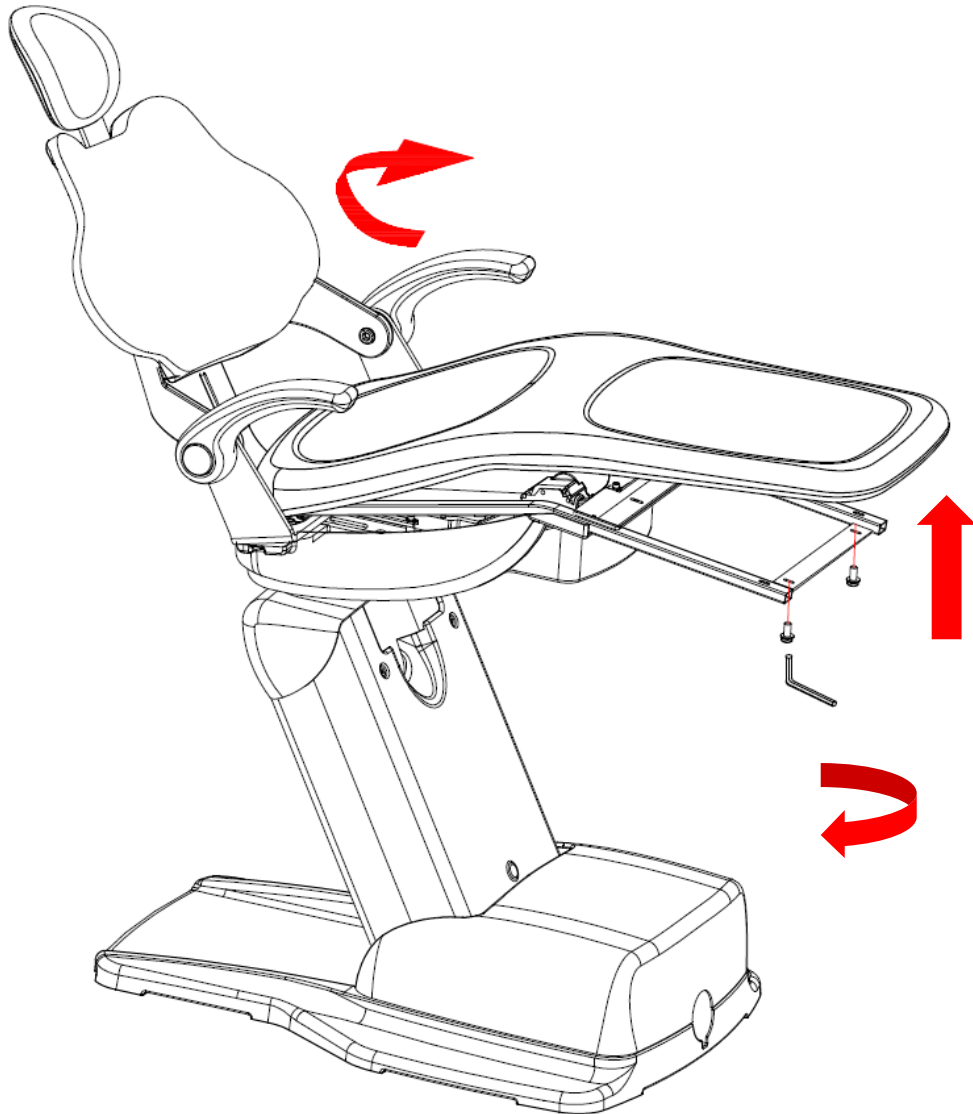

8 Reserved lines

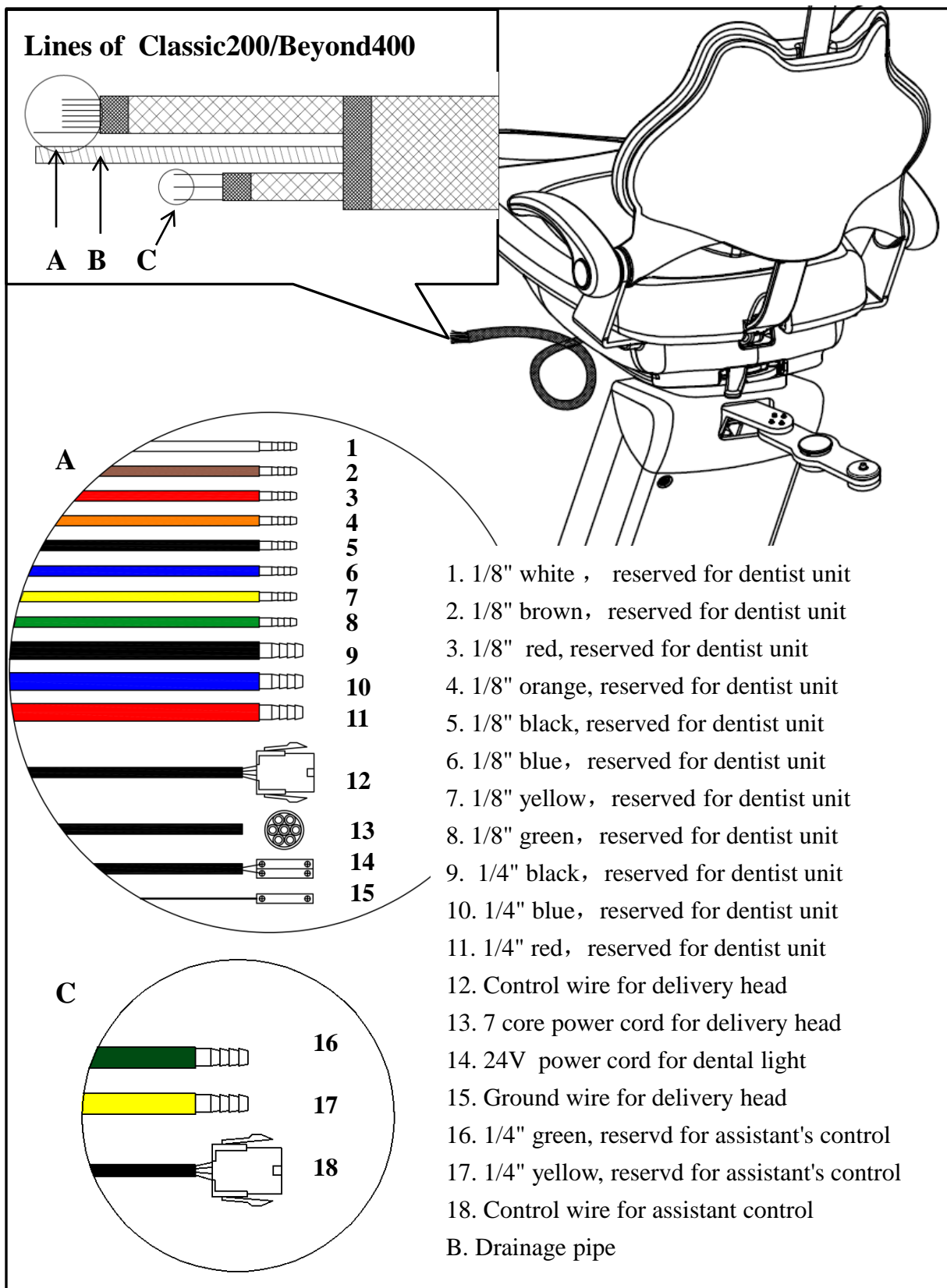

Lines of Classic201/Beyond401

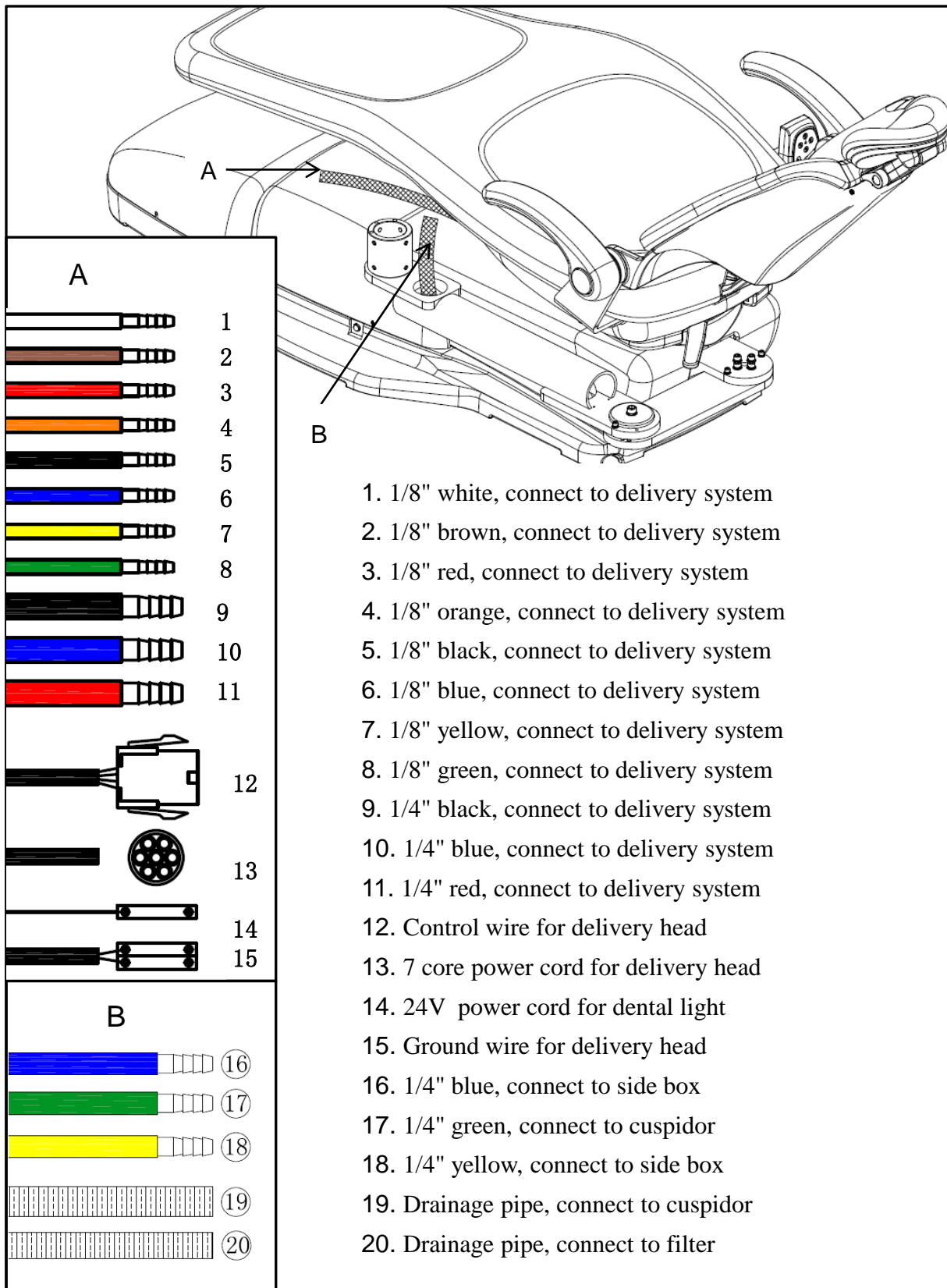

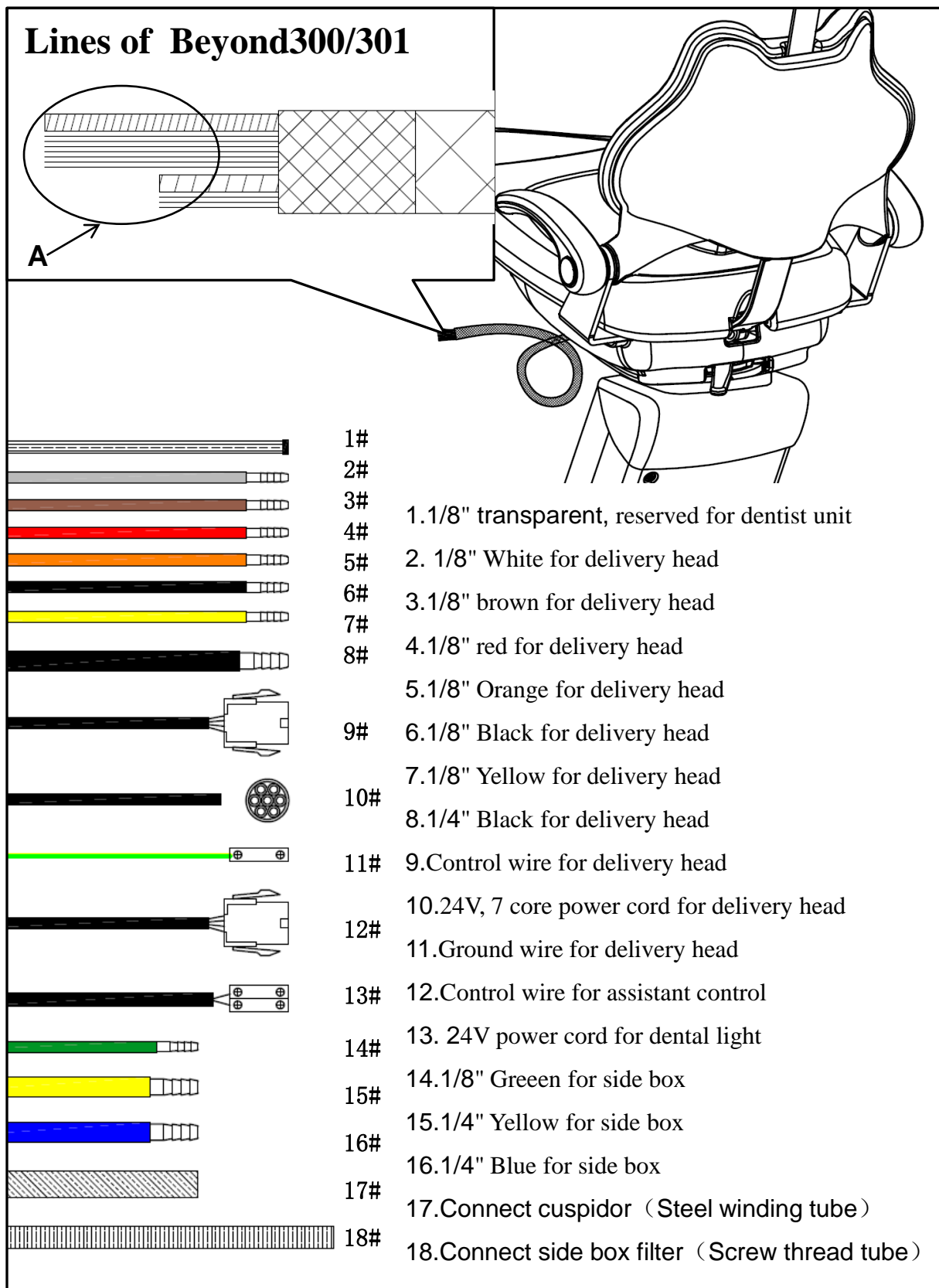

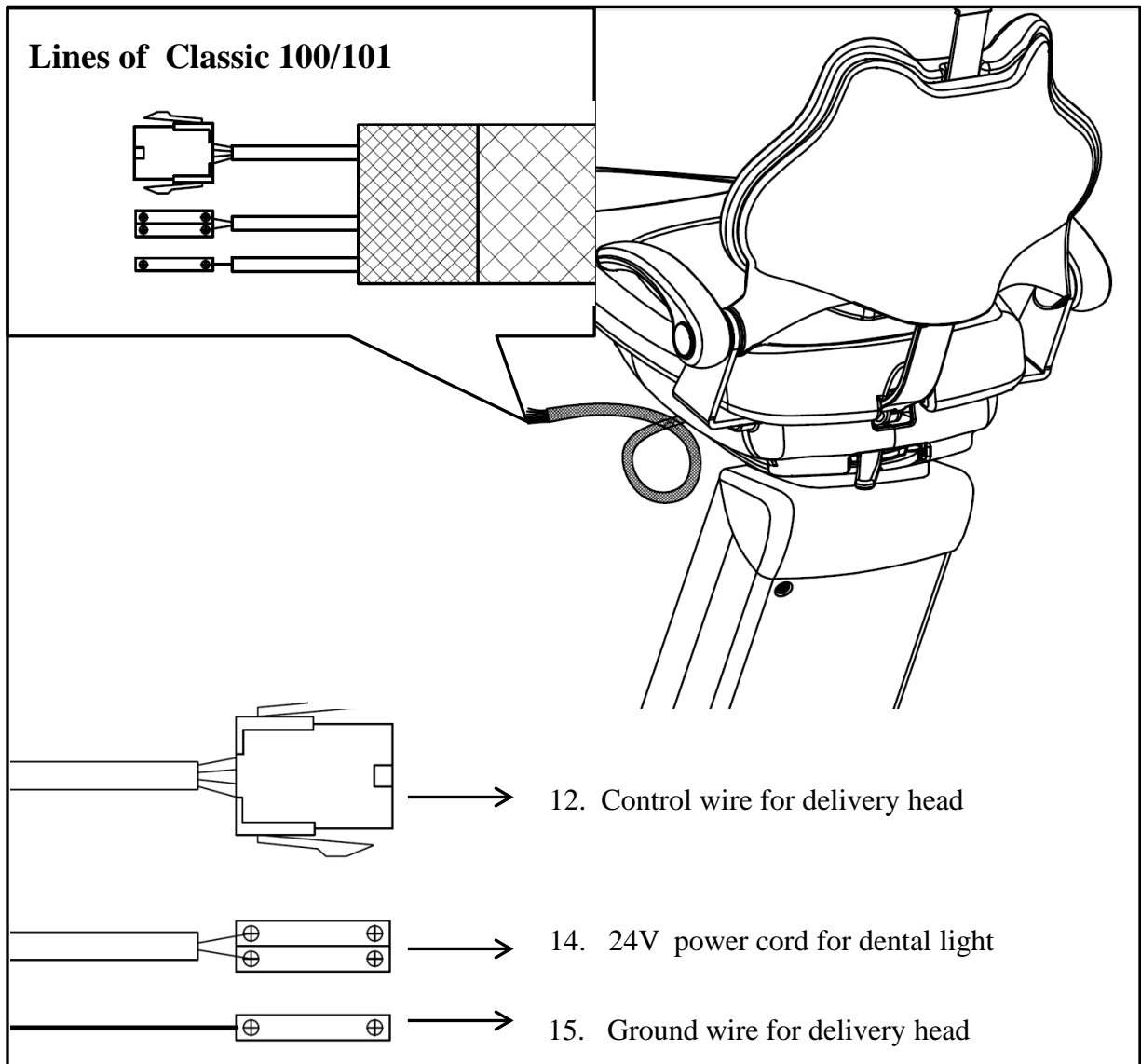

9 Upholstery Maintenance Instruction

The upholstery provides users unparalleled comfort, excellent aesthetics and reliable quality. The upholstery has a one-year warranty on defective materials and workmanship. This instruction ensures a longer life of the upholstery if it is properly maintained.

Cleaning

Users can clean the upholstery with mild solution, non-ionic detergent, water or cleaners without alcohol, bleach or ammonia. Do not use abrasive cleansers or tools which can permanently damage the surface of upholstery.

Disinfection

The dental system suggests disinfecting the leather once a month with a 3% hydrogen peroxide solution, leather cleaner or 3% multi-enzyme cleaner based on its instruction to ensure effective disinfection, and then fully wipe it with water.

Caution:

Do not disinfect the upholstery with **alcohol, potentiated glutaraldehyde disinfectant, liquid bleach, Benzammonium bromide (Benzalkonium chloride) disinfectant, Benzoyl chloride ammonium propanol disinfectant or any kind of acid and alkaline disinfectants** which will lead to the aging, cracking or color difference of the upholstery. If the improper material is used and the upholstery is damaged, such as leather cracking or aging and color difference, this warranty becomes void.

10 Connecting diagrams

Connecting diagram (Hydraulic system)

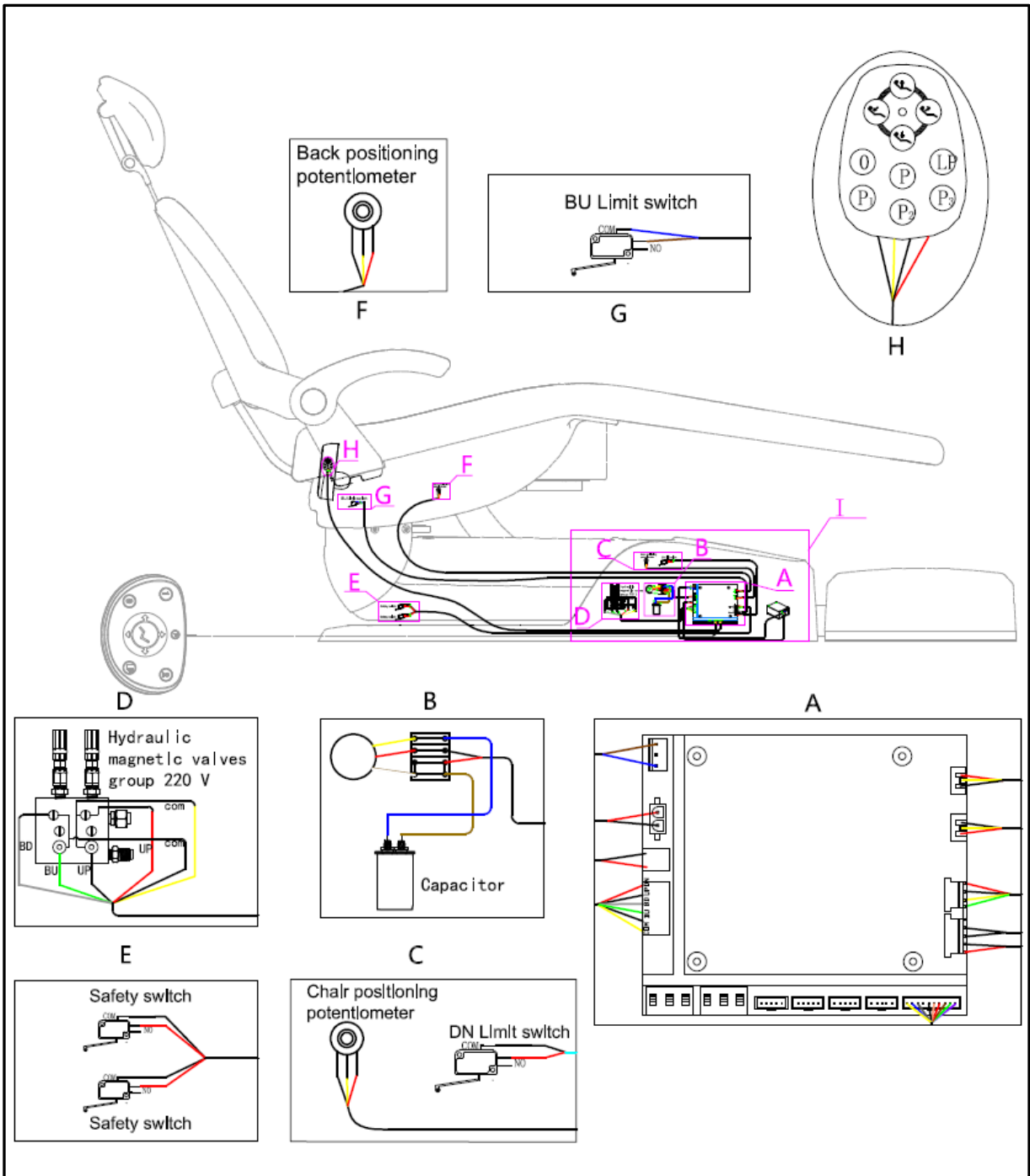

We reserve the right to make any alterations which may be due to technical improvements.



710422

ADS Dental System Inc.

Add: 1590 S Milliken Ave., unit A, Ontario, CA 91761

Tel: (626) 620 0456

E-mail: ads@adsequip.com

<http://www.adsequip.com/>