

# **Installation manual of AJ10 International dental chair**

# C O N T E N T S

<b>1</b>	<b>Introduction.....</b>	<b>1</b>
1.1	Products information.....	1
1.2	Symbols explanation.....	1
<b>2</b>	<b>Composition.....</b>	<b>3</b>
<b>3</b>	<b>Parameters.....</b>	<b>4</b>
3.1	Specifications.....	4
3.2	Size.....	4
<b>4</b>	<b>Preparations.....</b>	<b>5</b>
4.1	Attentions.....	5
4.2	Tools recommended.....	6
4.3	Installation requirements.....	7
<b>5</b>	<b>Installation.....</b>	<b>7</b>
5.1	Place the chair .....	7
5.2	Fix the chair.....	8
5.3	Install the backrest.....	9
5.4	Install the headrest .....	10
5.5	Install backrest upholstery.....	11
5.6	Install seat upholstery.....	12
<b>6</b>	<b>Operations.....</b>	<b>13</b>
6.1	Power.....	13
6.2	Operate by foot control.....	13
6.3	Chair positions description.....	14
6.4	Dual articulating headrest.....	15
<b>7</b>	<b>Regulation &amp; maintenance.....</b>	<b>17</b>
7.1	Remove the upholstery .....	17
<b>8</b>	<b>Reserved lines .....</b>	<b>19</b>
<b>9</b>	<b>Maintenance &amp; sterilization instructions .....</b>	<b>20</b>
<b>10</b>	<b>Connecting diagrams.....</b>	<b>21</b>







# 1 Introduction

## 1.1 Product information

- Name:** Dental chair
- Model:** AJ10 International
- Working conditions:**
  - ① Ambient temperature: 5 °C ~ 40 °C ;
  - ② Relative humidity: ≤ 80% ;
  - ③ Air pressure: 86 kPa ~ 106 kPa ;
  - ④ Nominal voltage: AC110 V ± 22 V ;
  - ⑤ Nominal frequency: 60 Hz ± 1 Hz ;









## 1.2 Symbols explanation

Table 1

Symbol	Explanation
 Manufacturer	 EU representative
 Producing date	 Serial number.
 Place with care	 Keep dry

# Installation manual of AJ10 International dental chair

---

<b>Symbol</b>	<b>Explanation</b>
 <p data-bbox="296 534 662 563">Refer to attached document</p>	 <p data-bbox="919 534 1115 563">Backrest Down</p>
 <p data-bbox="337 763 610 793">Avoid electric shock</p>	 <p data-bbox="938 763 1100 793">Backrest Up</p>
 <p data-bbox="355 995 591 1025">Ground protection</p>	 <p data-bbox="938 995 1100 1025">Chair Down</p>
 <p data-bbox="427 1236 518 1266">Notice</p>	 <p data-bbox="949 1236 1070 1266">Chair Up</p>

## 2 Composition

AJ10 International dental chair (figure 1) combined with new design concepts, provide a good balance for usability ,simplicity and comfortability.

**Figure 1 AJ10 International Dental Chair**

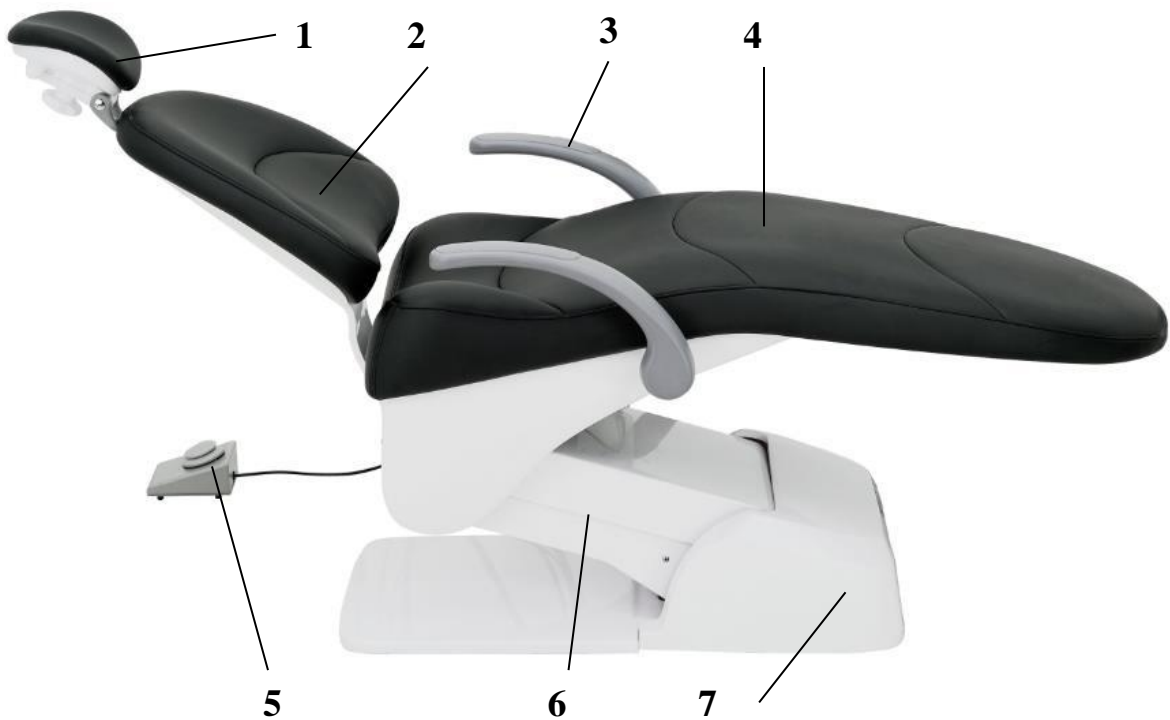

Item	Component	Item	Component
1	Headrest	5	Foot control
2	Backrest	6	Lifting arm
3	Armrest	7	Junction box
4	Seat		

### 3 Parameters

#### 3.1 Specifications

##### Load bearing

Patient bearing: Max 135kg



**Tip:** Specifications are subject to change without notice.

#### 3.2 Size (unit: mm)

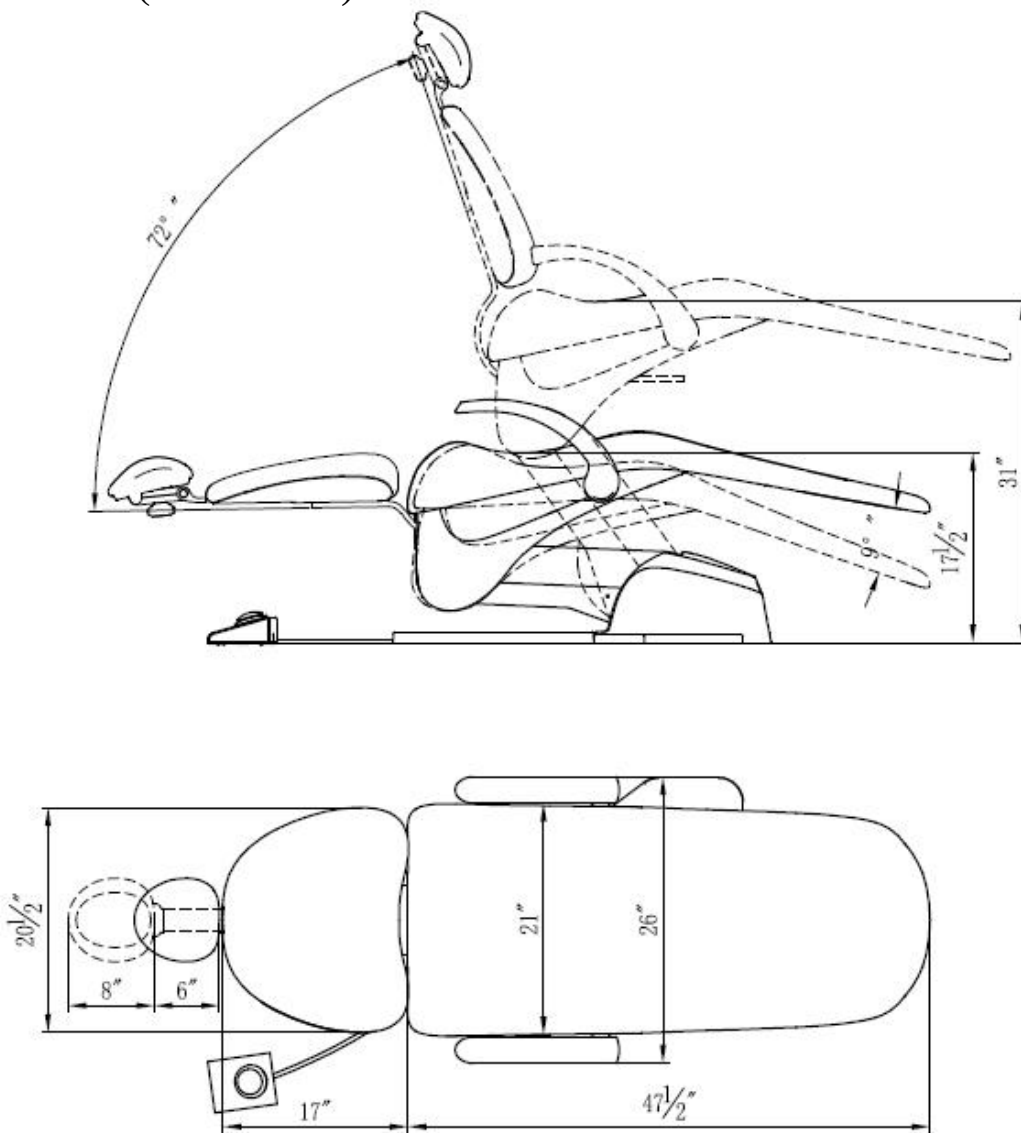

## 4 Preparations

### 4.1 Attentions

**Before install the unit, you should:**

- Clear all the debris in the room , and clean the floor thoroughly.
- Apply two manually operated valves for the air and water source.
- Exhaust the dirty water and air before connecting.
- May have no necessity to use all the component described in this document when installing. Components should be evaluated before installation.

**Before install the unit, please read the manual carefully:**

- Input voltage AC110 V ,60 Hz.
- Make sure the dental unit is in good grounding .
- All the electrical components and connections should be made by an authorized technician.
- Only fuse and accessories recognized by ADS technician can be used.
- This device should not operate in the environment of high temperature, high humidity, vibration ,flammability, unbalance, or dusty.
- Only the authorized spare parts can be used in this device.
- This dental unit should not come into contact with any object in its operational range of movement.
- This device can not be used in the environment of strong magnetic, electromagnetic.

**Leather maintenance:**

- 1、 No organic solvent or alkaline detergent (such as: gasoline、 alcohol ,etc.), or the leather will crack, be smelly or fade;
- 2、 No exposure, keep the room in good ventilation (exposure can cause the leather crack, bad ventilation lead to go mouldy) ;
- 3、 Mention the patient to remove edged tools(like keys)before operation, to avoid scratch the leather.

## 4.2 Tools recommended

The tools and instruments need to prepare before installation.

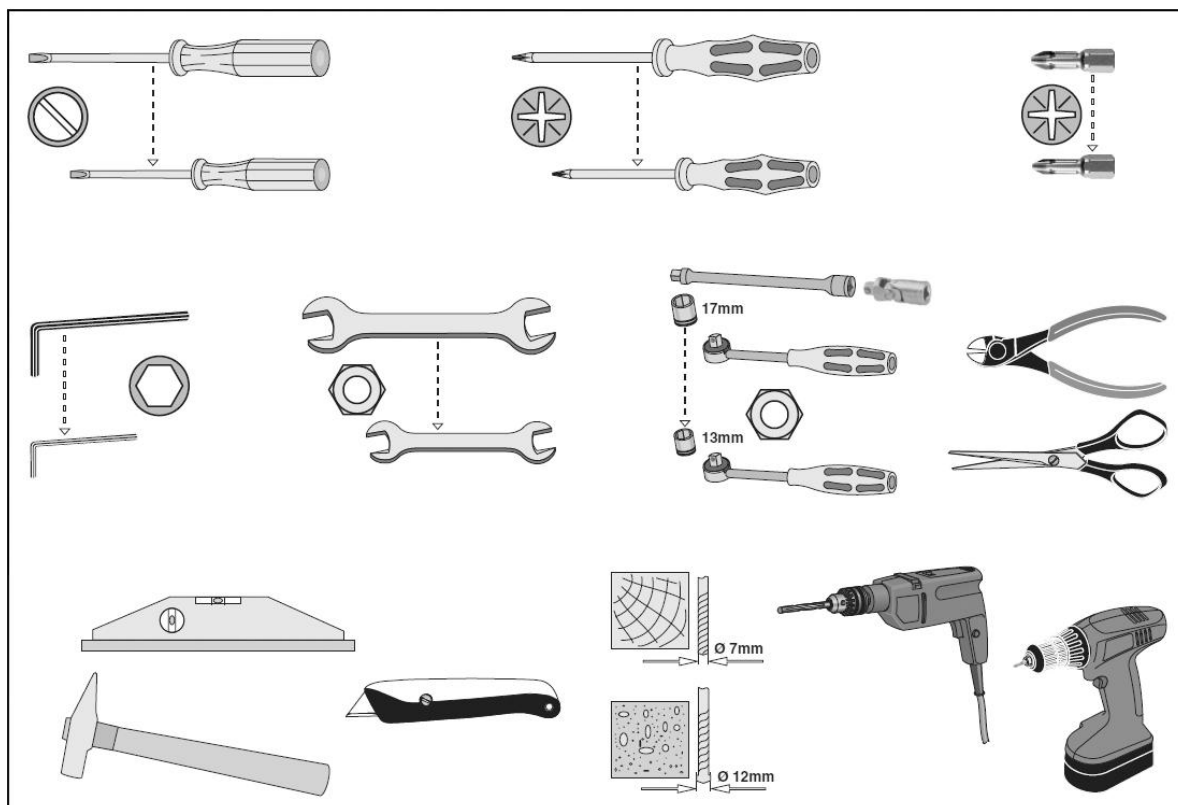



### 4.3 Installation requirements

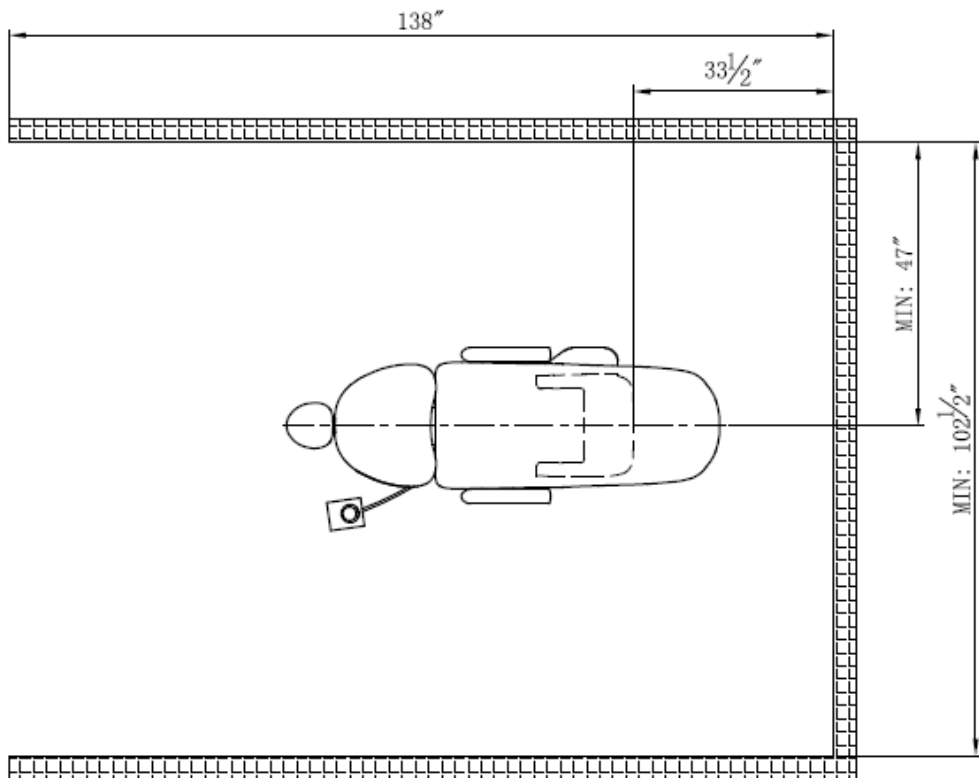

Note: Sizes above are the minimum that required.

## 5 Installation

### 5.1 Place the chair

1. Remove all debris and cardboards around the chair.
2. Hold the handrail and the front of the frame, uplift the chair and place the chair on the right place.
3. Remove binding belt and packages.

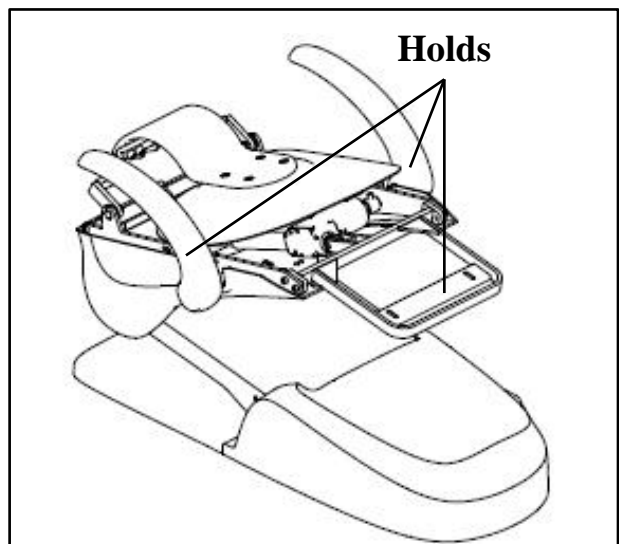

## 5.2 Fix the chair



**Attentions:**

- 1.The chair must be fixed on the floor for ensuring stability, for it can be seriously damaged by wrong fixation.**
- 2.Check out the material of the floor on the installing place. Please contact the authorized contractor to thickening the floor if its thickness is less than 82 mm.**

- 1、 Power on and activate the unit.
- 2、 Step the button  on foot control , raise the unit.
- 3、 Unit switched off and power disconnected.

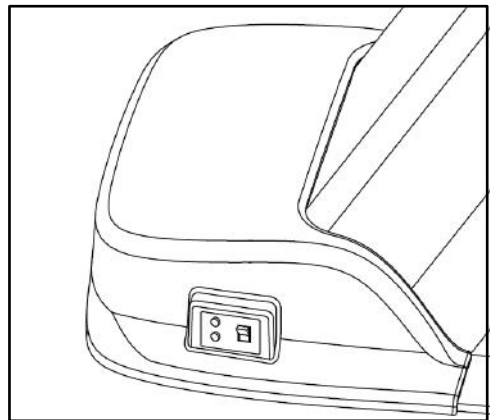

- 4、 Remove the cover and mark the installing position , then move the unit away.

Drill on the marked position, press the explosive bolt, then return the unit to its position and tighten the screw.

### 5.3 Install the backrest

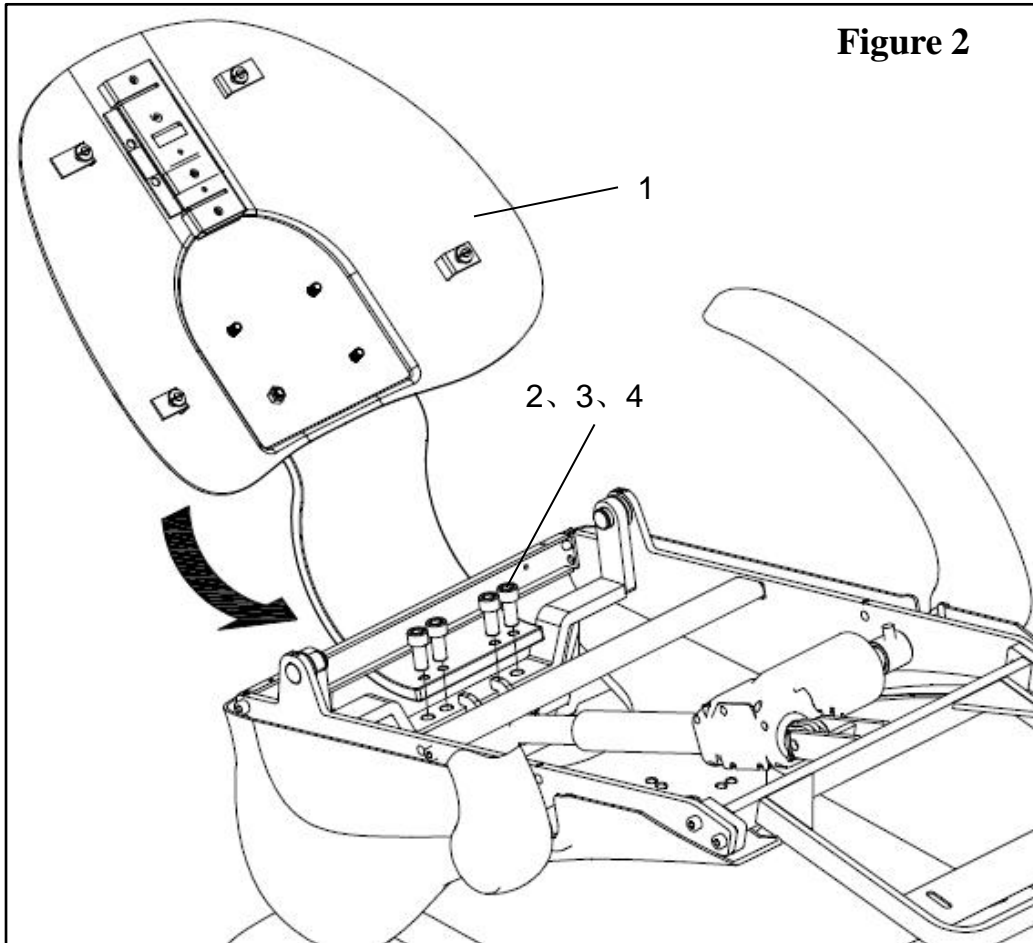

Figure 2

1	Metal backrest
2	M10*45 Hexagon socket cap screw
3	Φ10 Spring washer
4	Φ10 Plain washer

Fix the backrest on the chair frame with three M10\*45 screws.

## 5.4 Install the headrest

Figure 3

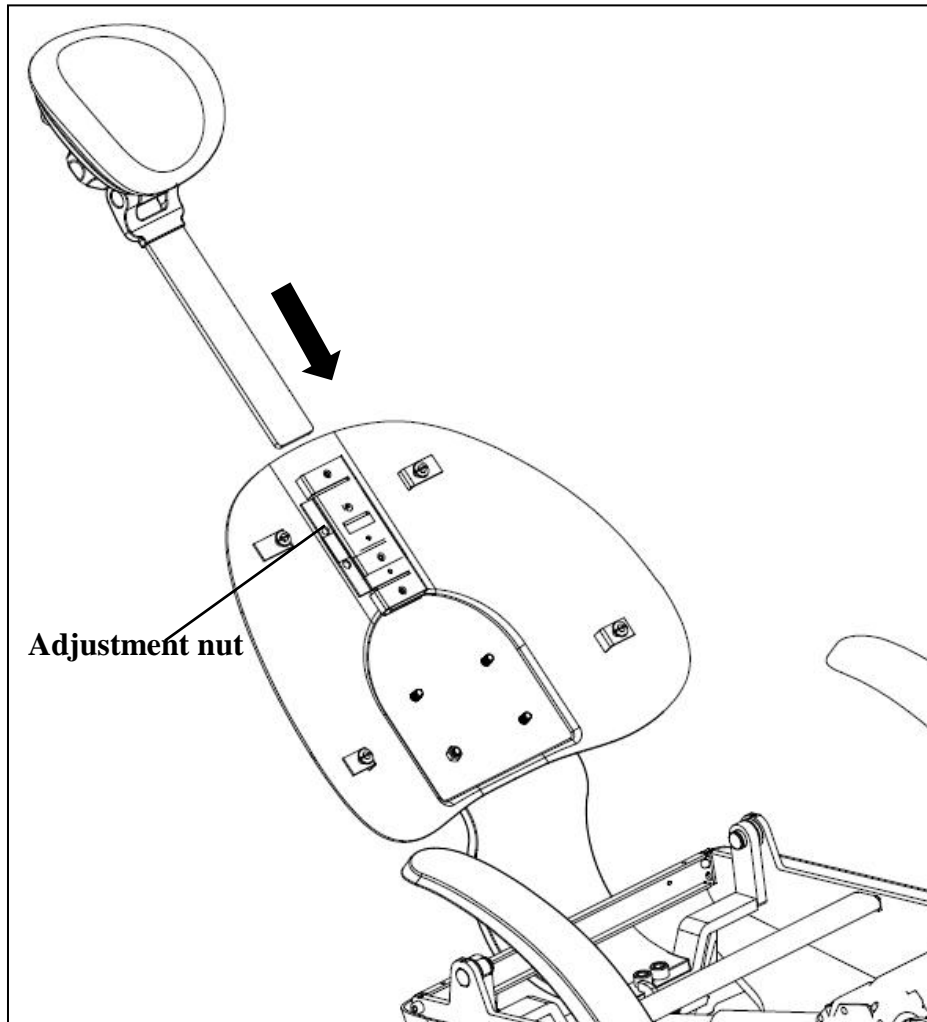

Install the headrest

1. Push the headrest glidebar into the slot of the backrest.
2. Adjust the nut to get proper damping force.
3. Fix the upholstery to the headrest bottom plate.

## 5.5 Install backrest upholstery

Figure 4

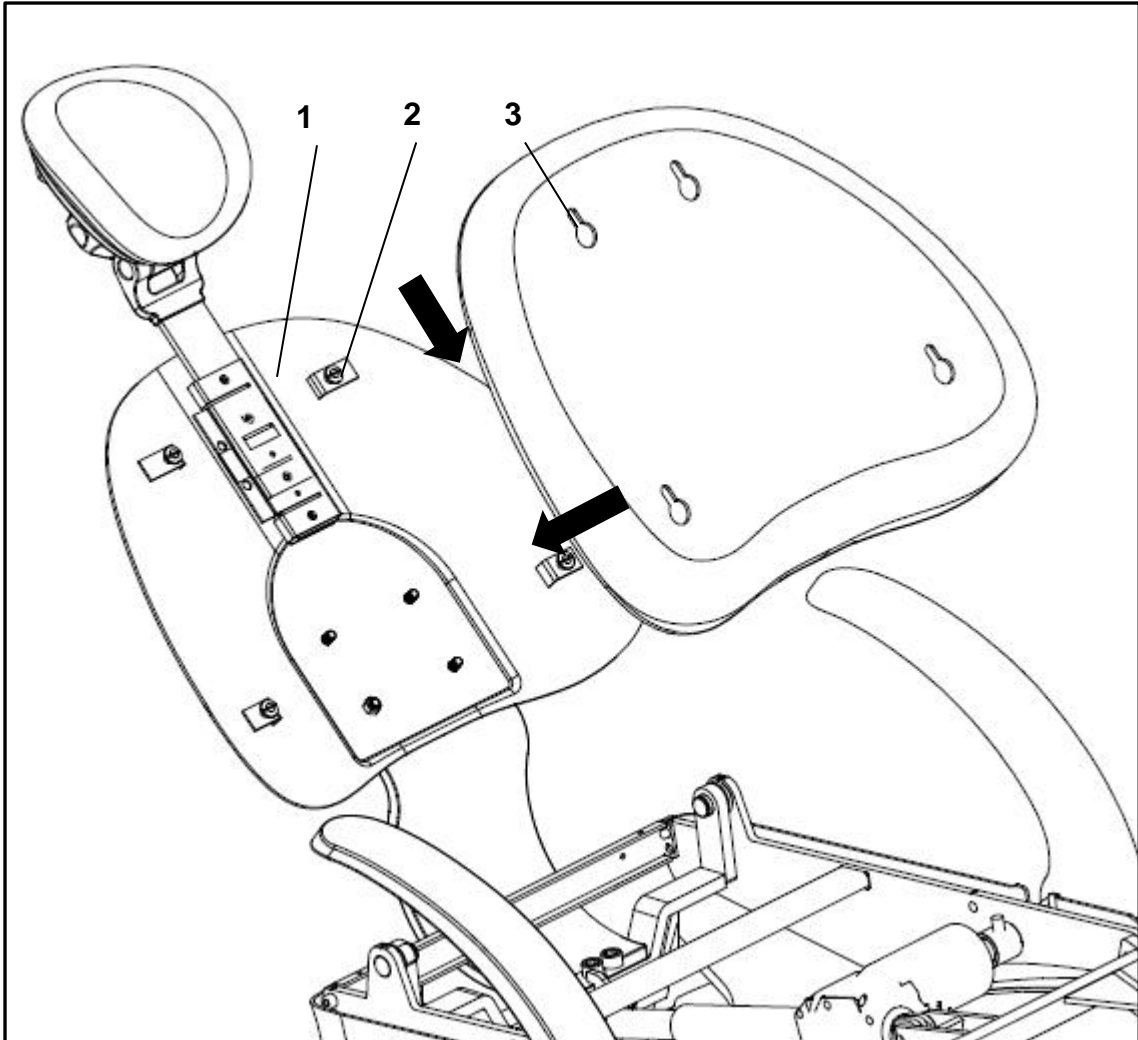

1、 Metal backrest

2、 Fixing shaft

3、 Backrest upholstery

When installing the upholstery, you should put the upholstery on the backrest with the shaft head pass through corresponding keyholes of the upholstery, then push the upholstery in force till it's fixed.

## 5.6 Install the seat upholstery

Figure5

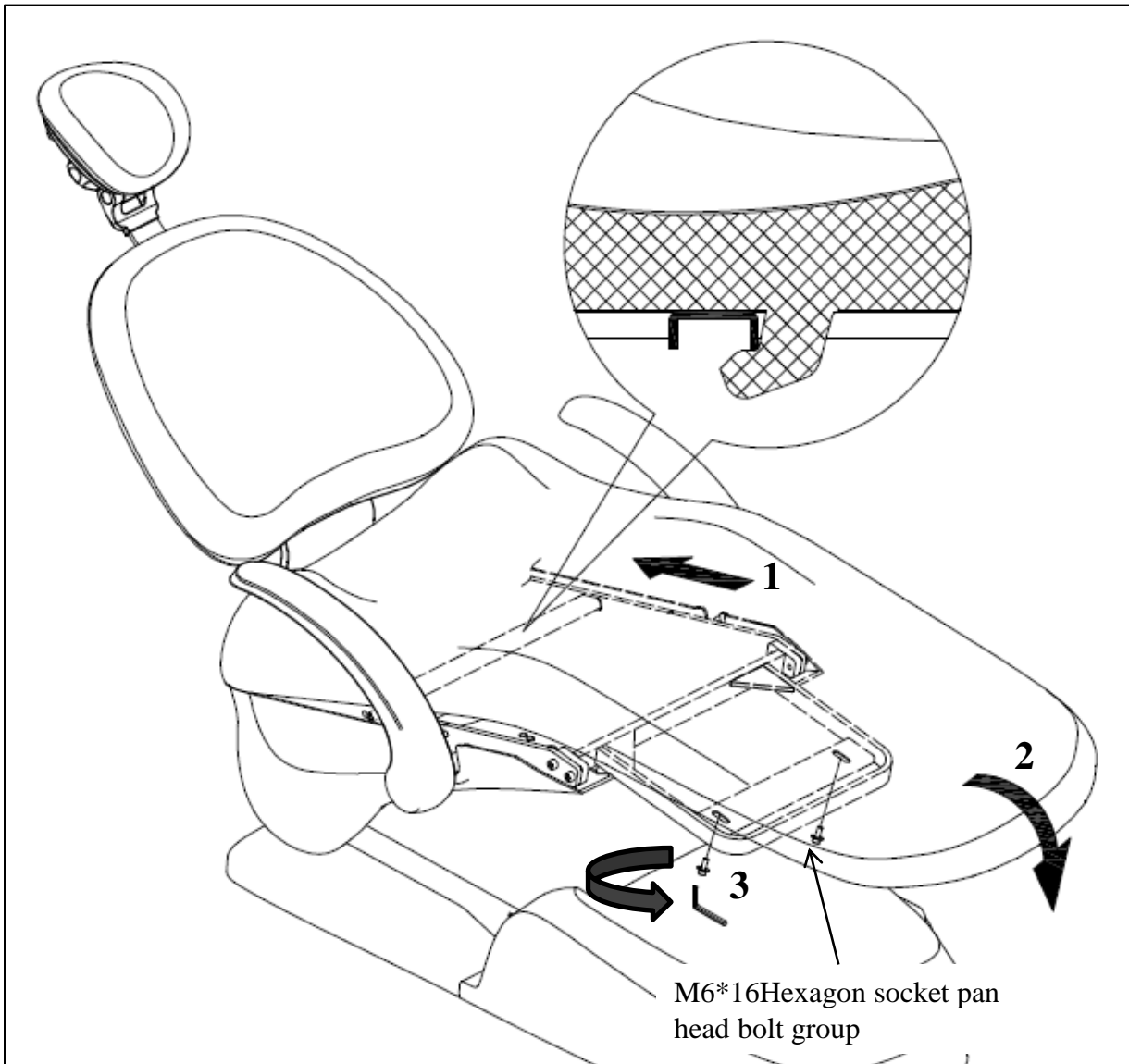

### Install the seat upholstery

Put the upholstery onto the chair frame, let the chair frame get stuck in the grabs that on the rear bottom of the upholstery, and fix the upholstery by two M6\*16 screws.

## 6 Operations

### 6.1 Power

The power switch of the power box controls power supplying of the dental chair and its delivery system. Switch on and you can get the power, switch off for not using in a long term, or before maintenance .

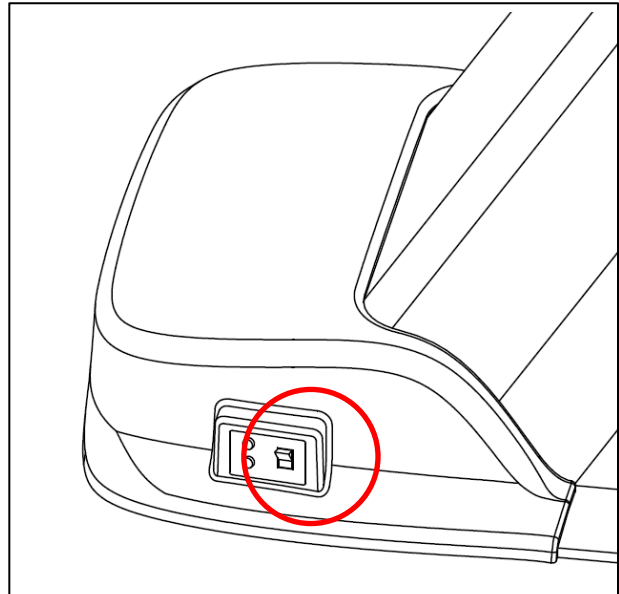

**Figure 6**

### 6.2 Operate by foot control

Raise or low the chair by pressing base up/down button , step on the up/down arrow on the foot control till the chair is in best position.

Move the backrest by pressing backrest up/down button , step on the left/right arrow till the chair is in best position .



**Figure 7**

## 6.3 Chair positions description

### a. Backrest Up



Press this button continuously and the backrest will move upwards. When the backrest reach the desired position, stop pressing the button and the backrest will stop immediately.

**NOTE: If you press the button continuously, when the chair backrest reach the limit position, it will automatically stop the movement.**

### b. Backrest Down



Press this button continuously and the backrest will move downwards. When the backrest reach the desired position, stop pressing the button and the backrest will stop immediately.

**NOTE: If you press the button continuously, when the chair backrest reach the limit position, it will automatically stop the movement.**

### c. Chair up



Press this button continuously and the chair will move upwards. When the backrest reach the desired position, stop pressing the button and the backrest will stop immediately.

**NOTE: If you press the button continuously, when the chair backrest reach the limit position, it will automatically stop the movement.**

### d. Chair down



Press this button continuously and the chair will move downwards. When the backrest reach the desired position, stop pressing the button and the backrest will stop immediately.

**NOTE: If you press the button continuously, when the chair backrest reach the limit position, it will automatically stop the movement.**





**e. Original position**

Press the button, the chair and backrest will move to the original position automatically(Original position : backrest highest , the chair lowest) and light off . Press this button again , the chair returns to former position and light on. The chair shall stop at a new position by halfway stop.



**f. Spitting button**

Press the button, the chair and backrest will move to spitting position automatically(Spitting position : backrest highest , the chair is still) and light off . Press this button again , the chair returns to former position and light on. The chair shall stop at a new position by halfway stop.

## 6.4 Dual articulating headrest

**Figure 9 Headrest adjustment**

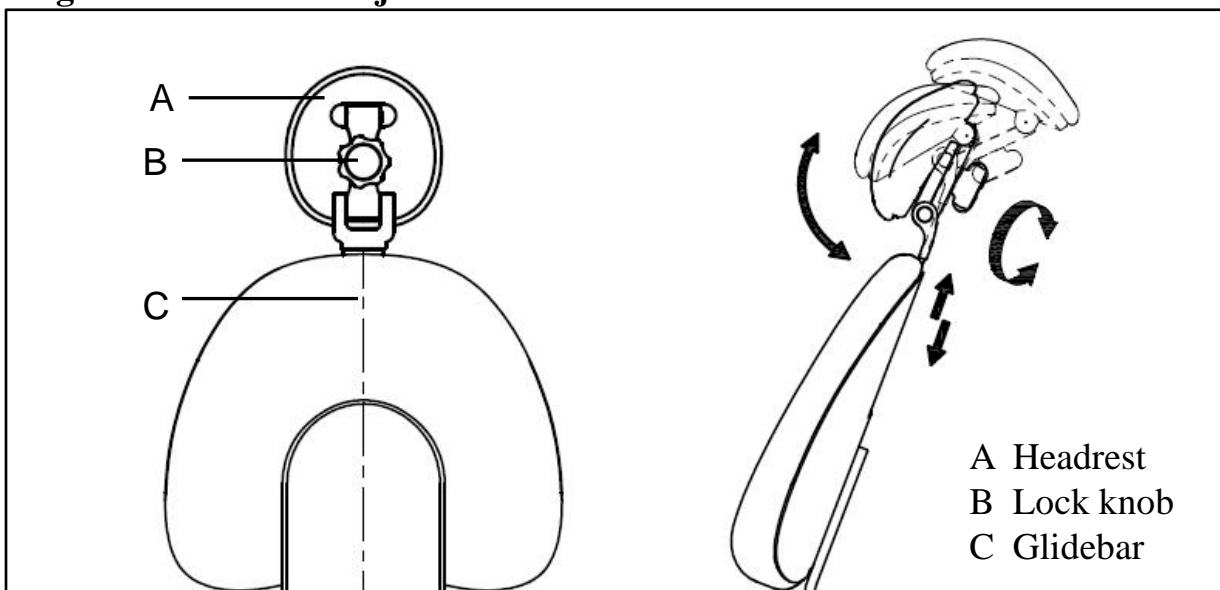

**NOTE:**

Please fix the headrest after adjustment to avoid patient's head not being settled.

**Figure 10 Fix the headrest for a wheelchair**

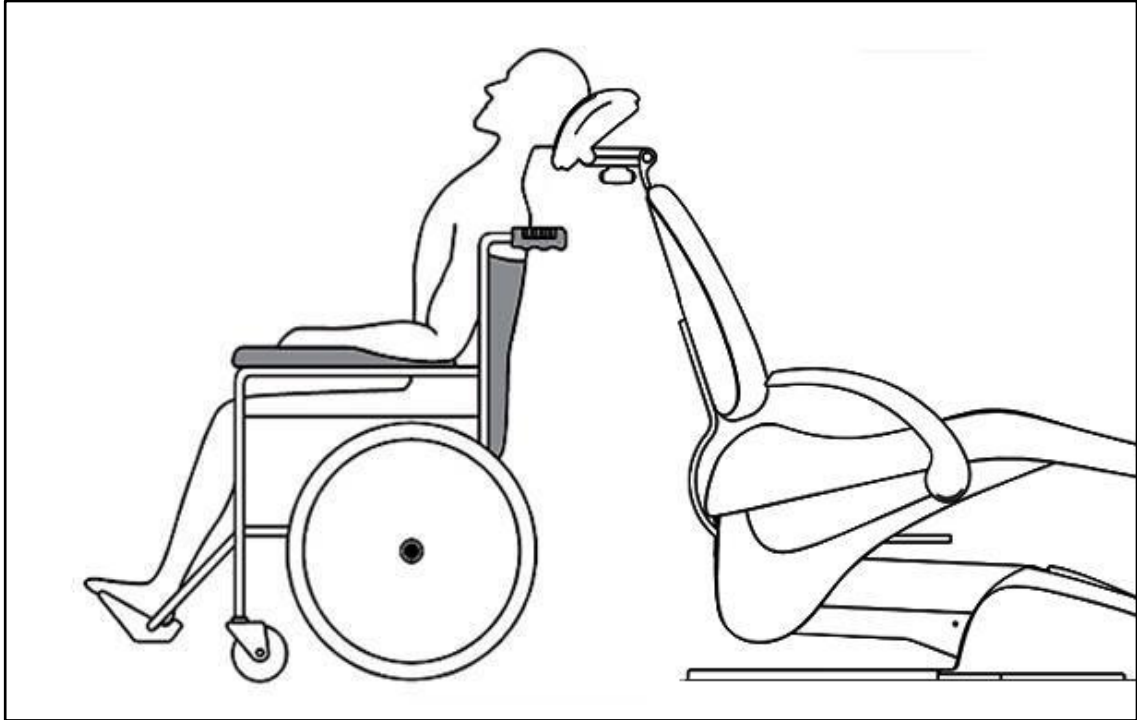

**Fix the headrest for a wheelchair:**

1. Backrest of the dental chair is fully raised.
2. After reposition the headrest ,raise or descend the chair to adjust heights. Patient's position should also be adjusted to put the wheelchair and dental chair back to back together.
3. Make sure the wheelchair is locked.

## 7 Regulation & maintenance

### 7.1 Remove the upholstery

The special design of upholstery is easy to remove and replace. They are installed on backrest, seat and headrest of the chair .

#### Backrest upholstery

To take off the upholstery from backrest, you should hold the bottom edge of gasket firmly and lift it up (1 inch or 25 mm) , then lift the upholstery from the backrest of the chair ( Figure15).

To reinstall the upholstery, you can put the keyhole of gasket on nail head, then push till the gasket is fixed.

**Figure 15 Remove the backrest upholstery**

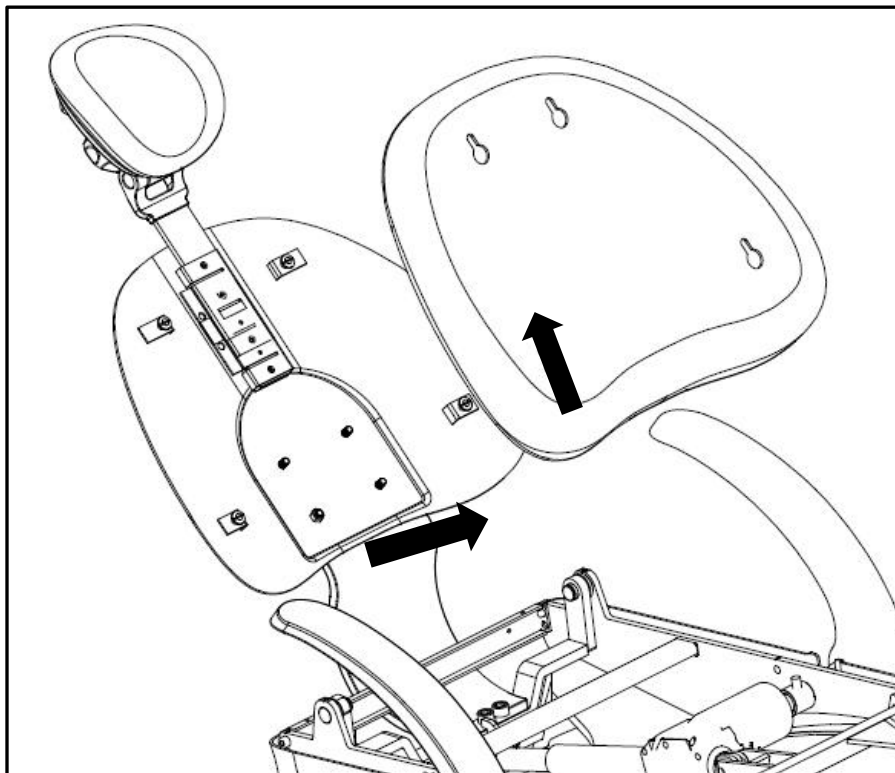

### Seat upholstery

Loose the screw at the front end of the upholstery, push the upholstery forward, then remove the seat upholstery.

**Figure 16 Remove the seat upholstery**

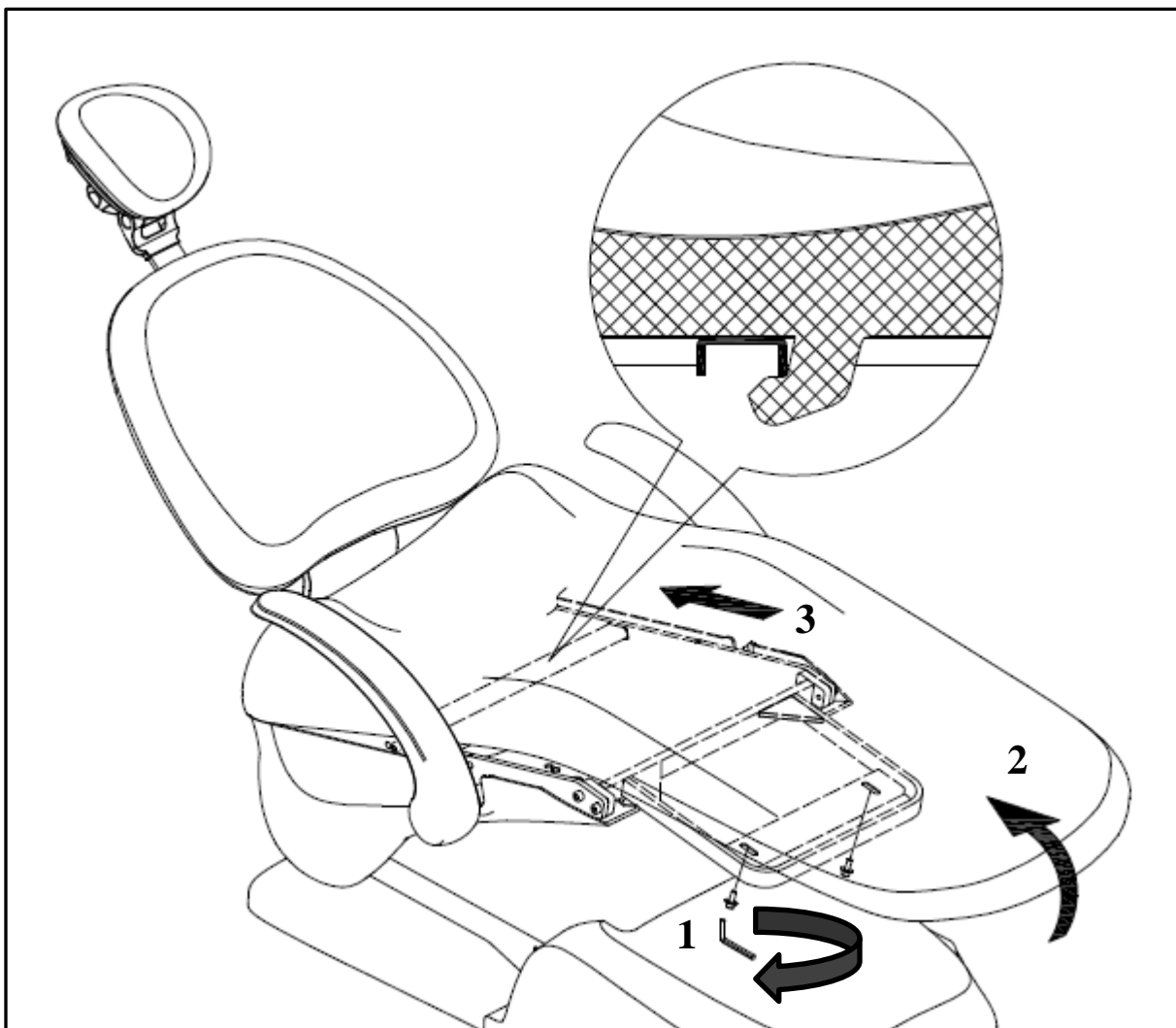

## 8 Reserved lines

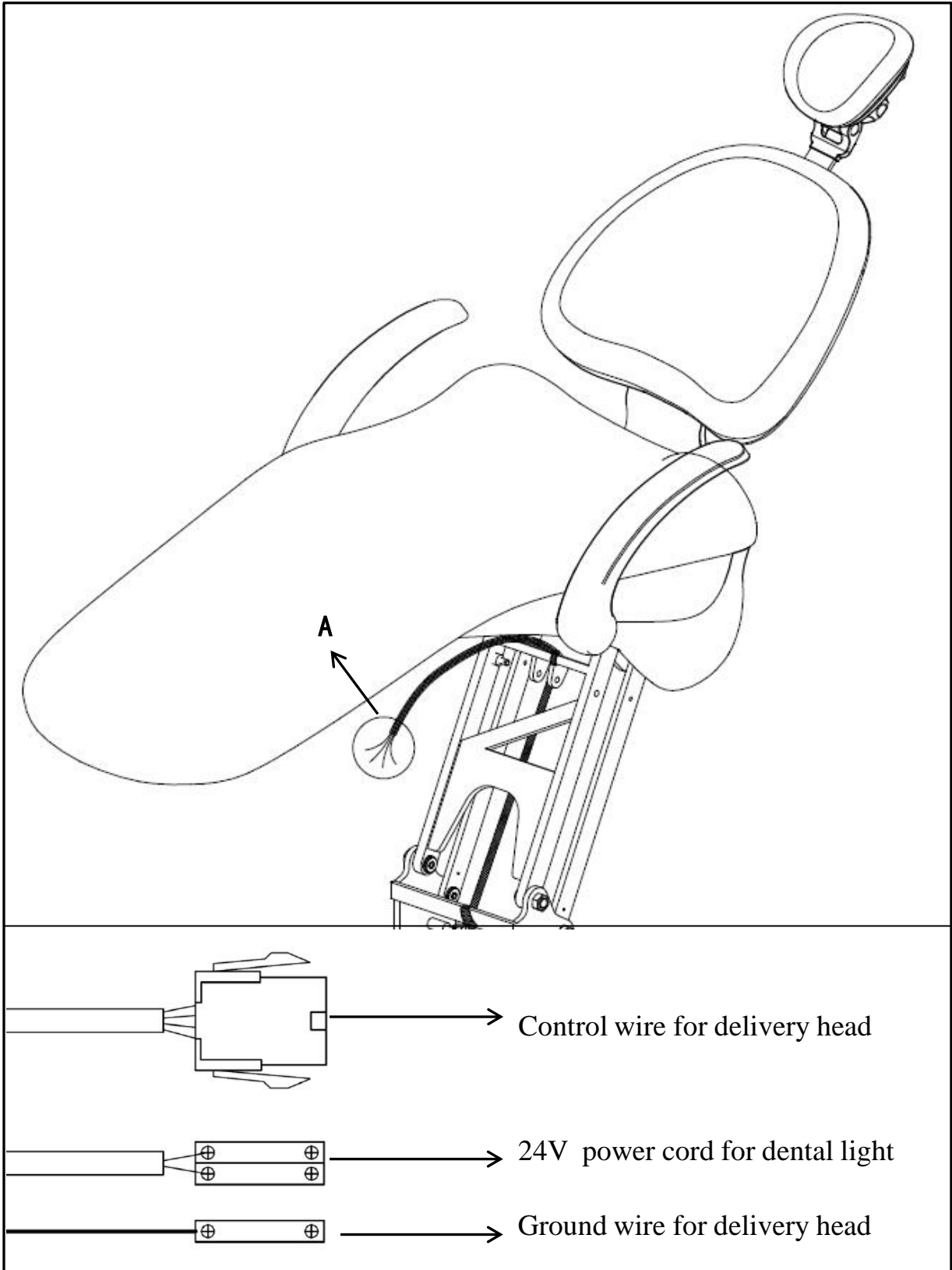

## **9 Maintenance & sterilization instructions**

### **Touch surface & transfer surface**

Touch surface refers to the surface area that need contact in dental treatment while can be potential cross contamination points.

Transfer surface refers to the surface area that contaminated from contacting with the instruments or other inactive object.

ADS company recommends isolating protection for all applicable touch surfaces and transfer surfaces. The partition used must be a plastic film approved the Food & Drug Administration. The plastic films should be taken off and discarded after the treatment of each patient.

## 10 Connecting diagrams

### Connecting diagram (Electric system)

